



Portable Gas Monitor GX-8000 Operating Manual (PT0-098)

Request for the Customers

- Read and understand this operating manual before using this gas monitor.
- Use it in accordance with this operating manual.
- Regardless of warranty period, we shall not make any indemnification for accidents and damage caused by using this gas monitor.
Make sure to read the warranty policy specified on the warranty.
- Because this is a safety unit, a regular maintenance for every six months and daily maintenance must be performed.
- If any abnormality is found in the gas monitor, notify it to RIKEN KEIKI immediately.
(Visit our Web site to find your nearest RIKEN KEIKI office.)

RIKEN KEIKI Co., Ltd.

2-7-6 Azusawa, Itabashi-ku, Tokyo, 174-8744, Japan

Phone : +81-3-3966-1113

Fax : +81-3-3558-9110

E-mail : intdept@rikenkeiki.co.jp

Web site : <http://www.rikenkeiki.co.jp/>

Safety information

The Portable Gas Monitor Model GX-8000 is a gas monitor designed to provide continuous exposure monitoring of combustible gas, oxygen (O₂), toxic gas such as carbon monoxide (CO) and hydrogen sulfide (H₂S) in hazardous environments. The gas sample is sucked in by build-in micro pump.

The battery can be selected either Li-ion battery or alkaline dry battery.

Li-ion battery unit is called BUL-8000 and alkaline dry battery unit is called BUD-8000.

The battery unit can be changed even by the end users.

Specification for safety

•Ex ia II C T4 Ga

•  II 1 G Ex ia II C T4 Ga

•Ambient temperature range for use : -20°C to +50°C

•Ambient temperature range during battery charging : 0°C to +40°C

Electrical data

•Power supply of Li-ion battery unit : BUL-8000

Two parallel connected Li-ion cells used in battery pack BP-8000 are from type Maxell INR18650PB1. Um=250V.

•Power supply of alkaline battery unit : BUD-8000

Powered by three series AA size alkaline batteries , model LR6 by TOSHIBA.

•Backup battery type CR1220 manufactured by Maxell.

Certificate numbers

•IECEX Certificate number : IECEX KEM 10.0038

•ATEX Certificate number : KEMA 10ATEX 0085

List of standards

•IEC 60079-0:2011

•IEC 60079-11:2011

•IEC 60079-26:2006

•EN60079-0:2012

•EN60079-11:2012

•EN60079-26:2007

WARNING

•Do not charge in hazardous location.

•Do not charge it expect by genuine charger.

•Do not replace battery unit in hazardous location.

•Do not replace dry batteries in hazardous location.

•Do not attempt to disassemble or alter the instrument.

•Use only battery unit type BUD-8000 with three series connected Alkaline AA batteries, type LR6 manufactured by Toshiba, or use chargeable battery unit type BUL-8000.

INST. No. 0 0 0 0 0 0 0 0 0 0
 A B C D E

A: Manufacturing year (0-9)

B: Manufacturing month (1-9,XYZ for Oct.-Dec.)

C: Manufacturing lot

D: Serial number

E: Code of factory



RIKEN KEIKI Co., Ltd.

2-7-6 Azusawa, Itabashi-ku, Tokyo, 174-8744, Japan

Phone : +81-3-3966-1113

Fax : +81-3-3558-9110 GIII

E-mail : intdept@rikenkeiki.co.jp

Web site : <http://www.rikenkeiki.co.jp>

<Contents>

1	Outline of the Product.....	2
1-1.	Preface	2
1-2.	Purpose of use	2
1-3.	Definition of DANGER, WARNING, CAUTION, and NOTE	2
2	Important Notices on Safety	3
2-1.	Danger cases	3
2-2.	Warning cases.....	4
2-3.	Precautions	5
3	Product Components.....	7
3-1.	Main unit and standard accessories	7
3-2.	Names and functions for each part.....	8
4	How to Use.....	11
4-1.	Before using the gas monitor.....	11
4-2.	Preparation for start-up.....	11
4-3.	Basic operating procedures.....	16
4-4.	How to start the gas monitor.....	17
4-5.	How to detect	19
4-6.	Modes.....	23
4-7.	Air calibration mode.....	24
4-8.	Display/setting mode	26
4-9.	How to exit.....	33
5	Operations and Functions	34
5-1.	Gas alarm activation.....	34
5-2.	Fault alarm activation	36
5-3.	Other functions	36
6	Maintenance.....	37
6-1.	Maintenance intervals and items	37
6-2.	Gas calibration method.....	38
6-3.	How to clean.....	39
6-4.	Parts replacement	39
7	Storage and Disposal	42
7-1.	Procedures to store the gas monitor or leave it for a long time	42
7-2.	Procedures to use the gas monitor again	42
7-3.	Disposal of products.....	43
8	Troubleshooting.....	44
9	Product Specifications	46
9-1.	List of specifications	46
9-2.	List of accessories	48
10	Definition of Terms.....	49

Outline of the Product

1-1. Preface

Thank you for choosing our portable gas monitor GX-8000. Please check that the model number of the product you purchased is included in the specifications on this manual.



This manual explains how to use the gas monitor and its specifications. It contains information required for using the gas monitor properly. Not only the first-time users but also the users who have already used the product must read and understand the operating manual to enhance the knowledge and experience before using the gas monitor.

1-2. Purpose of use

This gas monitor is a multi gas type that enables simultaneous monitoring of all of the following five types of gases at the maximum: oxygen, combustible gases, and toxic gases (carbon monoxide and hydrogen sulfide) in the air and high-concentration combustible gases (vol%) in N₂ and inert gases. Detection results are not intended to guarantee life or safety in any way.

The gas monitor comes in several types for different combinations of gases to be detected. Check the specifications of the gas monitor before use and conduct gas detection properly in accordance with purposes. (See the list of gases to be detected at the end of this operating manual.) In addition to this operating manual, an operating manual for the data logger management program (option) is available for the gas monitor. Contact RIKEN KEIKI if it is needed.

1-3. Definition of DANGER, WARNING, CAUTION, and NOTE

 DANGER	This message indicates that improper handling may cause serious damage on life, health or assets.
 WARNING	This message indicates that improper handling may cause serious damage on health or assets.
 CAUTION	This message indicates that improper handling may cause minor damage on health or assets.
NOTE	This message indicates advice on handling.

Important Notices on Safety

2-1. Danger cases



DANGER

About explosion-proof

- Do not modify or change the circuit or structure, etc.
- When measuring the oxygen concentration, do not measure anything but a mixture of air and combustible gases or vapors and toxic gases.
- When using this gas monitor in a hazardous area, take the following countermeasures for preventing dangers resulting from electrostatic charges.
 - (1) Wear anti-static clothes and conductive shoes (anti-static work shoes).
 - (2) For indoor use, use the gas monitor while standing on a conductive work floor (with a leakage resistance of 10 MΩ or less).
- The battery units that can be connected are the BUL-8000(G) (certificate number TC19437) or BUD-8000(G) (certificate number TC19438).
- The specifications of the gas monitor are as follows:

Pump circuit:	Allowable voltage of 4.95 V, allowable current of 1.12 A, and allowable power of 1138 mW
Combustible gas sensor circuit:	Allowable voltage of 4.95 V, allowable current of 0.834 A, and allowable power of 853 mW
Buzzer circuit:	Allowable voltage of 4.95 V, allowable current of 0.431 A, and allowable power of 441 mW
Main circuit:	Allowable voltage of 4.95 V, allowable current of 0.717 A, and allowable power of 733 mW
Backup circuit:	3.0 VDC, 10 μA

About use

- While conducting measurement in a manhole or confined space, do not lean over or look into the manhole or closed space. It may lead to dangers because oxygen-deficient air or other gases may blow out.
- Oxygen-deficient air or other gases may blow out from the gas exhausting outlet. Never inhale the air or gases.
- High-concentration (more than LEL) gases may blow out. Never use fire near the gas monitor.

2-2. Warning cases



WARNING

Sampling point pressure

- The gas monitor is designed to draw gases around it under the atmospheric pressure. If excessive pressure is applied to the gas inlet and outlet (GAS IN, GAS OUT) of the gas monitor, detected gases may be leaked from its inside, thus leading to dangers. Be sure that excessive pressure is not applied to the gas monitor while used.
- Do not connect the gas sampling hose directly to a location with a pressure higher than the atmospheric pressure. The internal piping system may be damaged.

Handling of sensor

Do not disassemble the electrochemical type sensor or galvanic cell type sensor because they contain electrolyte. Electrolyte may cause severe skin burns if it contacts skin, while it may cause blindness if it contacts eyes.

If electrolyte is adhered on your clothes, that part on your clothes is discolored or its material is decomposed. If contact occurs, rinse the area immediately with a large quantity of water.

Fresh air adjustment in atmosphere

When the fresh air adjustment is performed in the atmosphere, check the atmosphere for freshness before beginning the adjustment. If other gases exist, the adjustment cannot be performed properly, thus leading to dangers when the gas leaks.

Response to gas alarm

Issuance of a gas alarm indicates that there are extreme dangers. Take proper actions based on your judgment.

Battery level check

- Before use, check that there remains sufficient battery power. When the gas monitor is used for the first time or is not used for a long period, the batteries may be exhausted. Either fully recharge the batteries or replace them with new ones before use.
- If a low battery voltage alarm occurs, gas detection cannot be conducted. If the alarm occurs during use, turn off the power and promptly recharge the batteries in a non-hazardous area.

Others

- Do not throw the gas monitor into fire.
- Do not wash the gas monitor in a washing machine or ultrasonic cleaner.
- Do not block the buzzer sound opening. No alarm sound can be heard.
- Do not remove the battery unit while the power is ON.

2-3. Precautions



CAUTION

Do not use the gas monitor where it is exposed to oil, chemicals, etc. Do not submerge the gas monitor under water on purpose.

- Do not use in a place where the gas monitor is exposed to liquids such as oil and chemicals.
- The gas monitor, being compliant to IP67, is not water-pressure-resistant. Do not use the gas monitor where a high water pressure is applied to it (under a faucet, shower, etc.) or submerge it under water for a long time. The gas monitor is water-proof only in fresh water and running water, and not in hot water, salt water, detergent, chemicals, human sweat, etc.
- The gas inlet and outlet are not water-proof. Be careful not to let water such as rainwater get into these parts. Because this may cause trouble and gas cannot be detected.
- Do not use the gas monitor where water or dirt gets accumulated. The gas monitor placed at such a location may malfunction due to water or dirt that gets into the buzzer opening, gas inlet, etc.
- Note that drawing in dirty water, dust, metallic powder, etc. will significantly deteriorate the sensor sensitivities. Be careful when the gas monitor is used in an environment where these elements exist.

Do not use the gas monitor in a place where the temperature drops below -20°C or rises over 50°C.

- The operating temperature of the gas monitor is -20 to 50°C. Do not use the gas monitor at higher temperatures, humidities, and pressures or at lower temperatures than the operating range.
- Avoid long-term use of the gas monitor in a place where it is exposed to direct sunlight.
- Do not store the gas monitor in a sun-heated car.

Observe the operating restrictions to prevent condensation inside the gas monitor or gas sampling hose.

Condensation formed inside the gas monitor or gas sampling hose causes clogging or gas adsorption, which may disturb accurate gas detection. Thus, condensation must be avoided. In addition to the operating environment, carefully monitor the temperature/humidity of the sampling point to prevent condensation inside the gas monitor or gas sampling hose. Please observe the operating restrictions.

Do not use a transceiver near the gas monitor.

- Radio wave from a transceiver near the gas monitor may disturb readings. If a transceiver is used, it must be used in a place where it disturbs nothing.
- Do not use the gas monitor near a device that emits strong electromagnetic waves (high-frequency or high-voltage devices).

Verify that the pump driving indicator is rotating before using the gas monitor.

If the pump driving indicator is not rotating, gas detection cannot be performed properly. Check whether the flow rate is lost.

Do not forget to perform a regular maintenance.

Since this is a safety unit, a regular maintenance must be performed to ensure safety. Continuing to use the gas monitor without performing a maintenance will compromise the sensitivity of the sensor, thus resulting in inaccurate gas detection.



CAUTION

Others

- Pressing buttons unnecessarily may change the settings, preventing alarms from activating correctly. Operate the gas monitor using only the procedures described in this operating manual.
- Do not drop or give shock to the gas monitor. The water-proof and explosion-proof properties and accuracy may be deteriorated.
- Do not use the gas monitor while recharging it.
- Whereas the gas monitor can detect oxygen, combustible gases, carbon monoxide, and hydrogen sulfide, the operating environment may include gases that have harmful effects on the sensors of this unit. (Different gases can be detected depending on the type.)

The gas monitor cannot be used in the presence of the following gases:

- (1) Sulfides (such as H₂S and SO₂) continuously existing in high concentrations
- (2) Halogen gases (such as chloride compounds and chlorofluorocarbons)
- (3) Silicone (Si compounds)

Do not use the gas monitor in the presence of the above gases (such as high-concentration sulfides, halogen gases, and silicone), which may shorten the sensor life significantly or cause malfunctions such as inaccurate readings.

In case the gas monitor is used for detection in the presence of silicone, etc., be sure to check the gas sensitivities before using it again.

Product Components

3-1. Main unit and standard accessories

After opening the package, check the main unit and accessories.
If anything in the following list is not included, contact RIKEN KEIKI.

<Main Unit>	<Standard Accessories>
<p>GX-8000 main unit</p>  <p>Li-ion battery unit</p>	<ul style="list-style-type: none"> • AC powered charger: 1 • Gas sampling probe and gas sampling hose: 1 • Shoulder strap: 1 • Operating manual • Product warranty   



DANGER

About explosion-proof

- Do not modify or change the circuit or structure, etc.
- When measuring the oxygen concentration, do not measure anything but a mixture of air and combustible gases or vapors and toxic gases.
- When using this gas monitor in a hazardous area, take the following countermeasures for preventing dangers resulting from electrostatic charges.
 - (1) Wear anti-static clothes and conductive shoes (anti-static work shoes).
 - (2) For indoor use, use the gas monitor while standing on a conductive work floor (with a leakage resistance of 10 MΩ or less).
- The battery units that can be connected are the BUL-8000(G) (certificate number TC19437) or BUD-8000(G) (certificate number TC19438).
- The specifications of the gas monitor are as follows:

Pump circuit:	Allowable voltage of 4.95 V, allowable current of 1.12 A, and allowable power of 1138 mW
Combustible gas sensor circuit:	Allowable voltage of 4.95 V, allowable current of 0.834 A, and allowable power of 853 mW
Buzzer circuit:	Allowable voltage of 4.95 V, allowable current of 0.431 A, and allowable power of 441 mW
Main circuit:	Allowable voltage of 4.95 V, allowable current of 0.717 A, and allowable power of 733 mW
Backup circuit:	3.0 VDC, 10 μA

NOTE

There are the following two combinations of battery units. The following information is printed on the battery unit for the sake of identification to prevent a mistake in combinations.

- BUL-8000 (certification number TC19437)=> BUL-8000(G)
- BUD-8000 (certification number TC19438)=> BUD-8000(G)

Additionally, a nameplate indicating a compatible model is affixed on the top of the battery unit. Check this information and use a correct combination.

Printing for identification

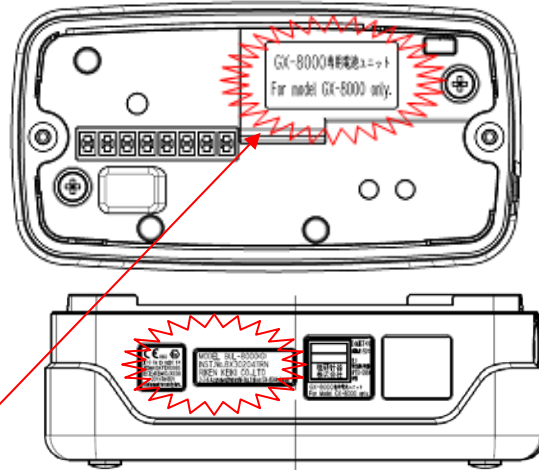

3-2. Names and functions for each part

<Outline Drawing>

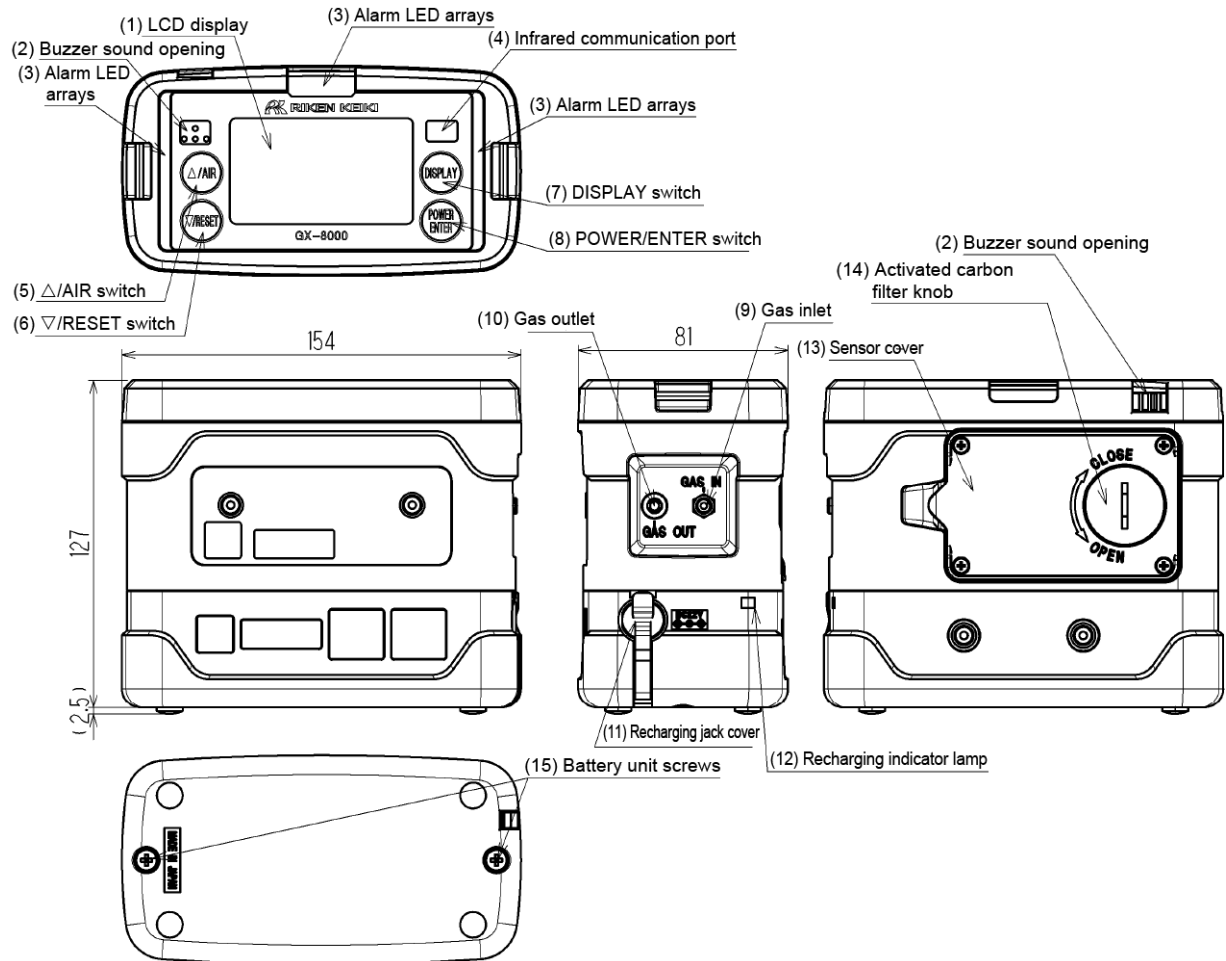

(1)	LCD display	Displays gas concentrations, alarms, etc.
(2)	Buzzer sound opening	Emits a buzzer sound at an alarm. (Do not block it.)
(3)	Alarm LED arrays	The lamp blinks in response to an alarm.
(4)	Infrared communication port	Used to carry out data communications with a PC in data logger mode.
(5)	▲/AIR switch	Keep this switch pressed to perform fresh air adjustment.
(6)	▼/RESET switch	When an alarm occurs, press this switch to reset the alarm.
(7)	DISPLAY switch	Press this switch to change between display modes.
(8)	POWER/ENTER switch	Turns on and off the power.
(9)	Gas inlet	Connect a sampling hose to this port.
(10)	Gas outlet	Exhausts the gas drawn into the gas monitor. (Do not block it.)
(11)	Recharging jack cover	Remove this cover to connect an AC powered charger and recharge the batteries.
(12)	Recharging indicator lamp	Lights up in red during recharging and goes off when recharging is completed.
(13)	Sensor cover	There are sensors inside. May be opened only when the sensor is to be replaced.
(14)	Activated carbon filter knob	Turn this knob to detach and replace the activated carbon filter. No activated carbon filter is used on a type that does not measure carbon monoxide. Keep this knob tightened at all times.
(15)	Battery unit screws	Turn these screws to detach and replace the battery unit.



CAUTION

- Do not jab the buzzer opening with a sharp-pointed item. The unit may malfunction or get damaged, allowing water or foreign substance, etc. to get inside.
- Do not remove the panel sheet on the display. The water-proof and dust-proof performances will be deteriorated.
- Do not affix a label on the infrared port. Infrared communications can no longer be conducted.

<LCD Display>

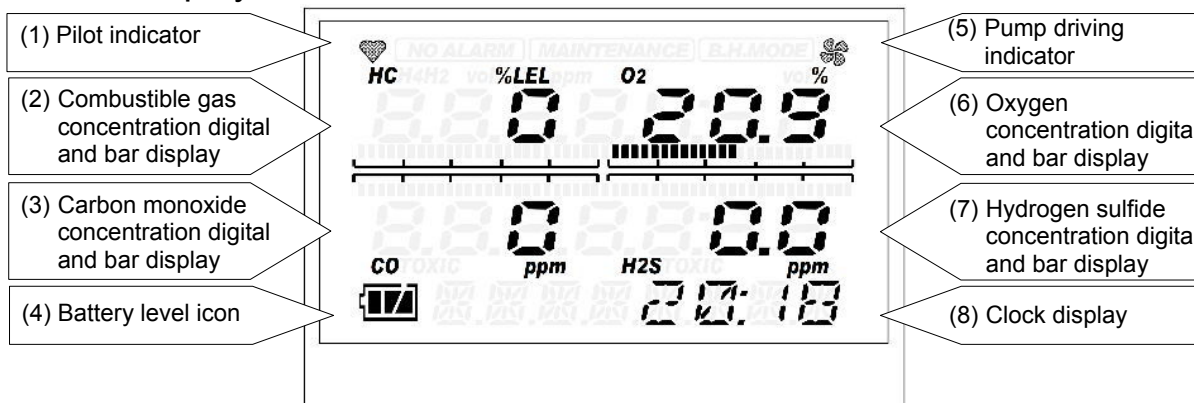

(1)	Pilot indicator	Displays the operating status in the detection mode. Normal: Blinking
(2)	Combustible gas concentration digital and bar display	Displays the gas concentration as a numeric value and a level in the bar graph.
(3)	Carbon monoxide concentration digital and bar display	Displays the gas concentration as a numeric value and a level in the bar graph.
(4)	Battery level display	Displays the battery level. See the information below for the meanings of battery level icons.
(5)	Pump driving indicator	Displays the suction status in the detection mode. Normal: Rotating
(6)	Oxygen concentration digital and bar display	Displays the gas concentration as a numeric value and a level in the bar graph.
(7)	Hydrogen sulfide concentration digital and bar display	Displays the gas concentration as a numeric value and a level in the bar graph.
(8)	Clock display	Displays the current time.

NOTE

The meanings of battery level icons are as follows:

: Sufficient / : Low / : Needs recharging

If the battery level is lower than the above, the inside of the battery icon starts to blink ().

How to Use

4-1. Before using the gas monitor

Not only the first-time users but also the users who have already used the product must follow the operating precautions.

Ignoring the precautions may damage the gas monitor, resulting in inaccurate gas detection.

4-2. Preparation for start-up

Before starting gas detection, read and understand the following precautions. Ignoring these precautions may prevent correct gas detection.

- Check that the battery level is sufficient.
- Check that there is no bend or hole in the gas sampling hose.
- Check that the filter in the gas sampling probe is free of dust or clogging.
- Check that the gas monitor, gas sampling probe, and gas sampling hose are connected properly.

<Recharging of Batteries>

When the gas monitor is used for the first time, or when the battery level is low, be sure to use the accessory AC powered charger to recharge the batteries.



CAUTION

- Use the dedicated AC powered charger.
- Recharge the batteries in a non-hazardous area.
- Recharge the batteries at ambient temperatures between 0 to 40°C.
- Do not use the gas monitor while recharging it. Correct measurements cannot be obtained. Furthermore, the batteries get deteriorated more quickly and may have a shorter life.
- The AC powered charger is not water-proof or dust-proof. Do not recharge the batteries while the gas monitor is wet.
- The AC powered charger is not explosion-proof.

(1) Open the recharging jack cover of the gas monitor.



CAUTION

Do not pull the recharging jack cover too hard. It may get damaged.

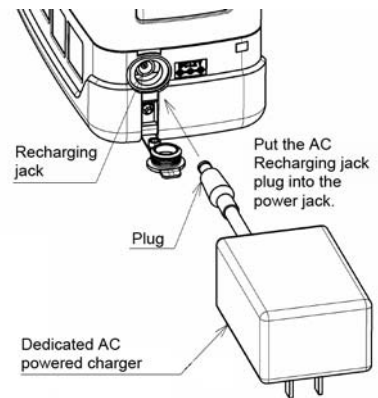

- (2) Put the plug of the AC powered charger into the recharging jack of the gas monitor.
- (3) Connect the AC powered charger to the wall electric outlet. When recharging is started, the recharging indicator lamp lights up (red).
(Recharging time: Three hours at the maximum until the batteries are fully recharged)
- (4) When recharging is completed, the recharging indicator lamp goes off.
- (5) When recharging is completed, disconnect the AC powered charger from the wall electric outlet.
- (6) Pull out the AC powered charger plug from the power jack of the gas monitor and reattach the recharging jack cover. Put the recharging jack cover as far as it will go.



CAUTION

- Do not use the gas monitor with the recharging jack cover detached. Dust or water may get into the gas monitor, causing it to malfunction. Replace the recharging jack cover if it is damaged.
- If the recharging jack cover is not completely closed, water may get in from the power jack. The same thing occurs if a minute foreign substance is caught beneath the cover.
- Disconnect the AC powered charger from the wall electric outlet while it is not in use.

NOTE

- During recharging, the battery pack may get hot, but this is not abnormal.
- The temperature of the gas monitor is high immediately after recharging is completed. Let it leave for 10 minutes or more before using it. Otherwise, correct measurements may not be obtained.
- When fully recharged batteries are recharged again, the recharging indicator lamp does not go on.

<Attaching Batteries> (when the optional unit BUD-8000(G) is used)

When the gas monitor is used for the first time, or when the battery level is low, attach new AA alkaline batteries.



CAUTION

<Replacement>

- Turn off the power of the gas monitor before replacing the batteries.
- Replace the batteries in a non-hazardous area.
- Replace all of the three batteries with new ones at one time.
- Pay attention to the polarities of the batteries.
- If the battery cover fixing screw is not completely tightened, the dry batteries may drop off or water may get in through the clearance. Water may also get in if a minute foreign substance is caught beneath the battery unit.

<Batteries>

- Use AA alkaline batteries.
Rechargeable batteries cannot be used.

- (1) Using a flathead screwdriver or coin, turn the battery cover fixing screw counterclockwise to open the battery cover.
- (2) Paying attention to the polarities of batteries, replace all the three batteries with new ones.
- (3) Close the battery cover and tighten the battery cover fixing screw.

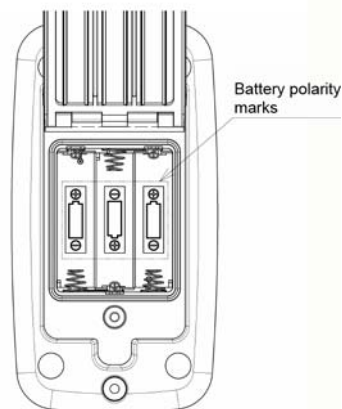
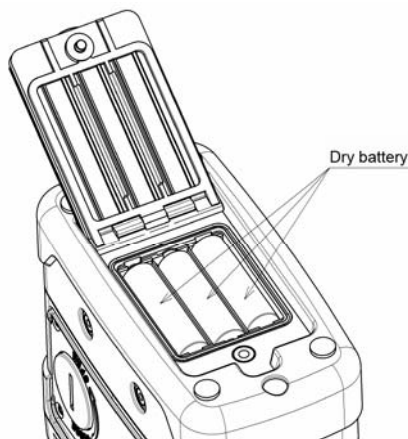
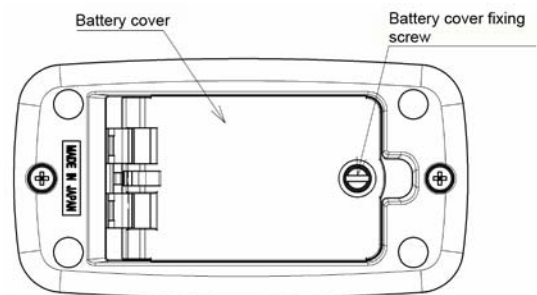

<Detaching Battery Unit>

- (1) Loosen the two battery unit screws.
(They need not be completely detached.)
- (2) Detach the battery unit.
- (3) Attach a new battery unit.

NOTE

Make sure that the battery unit is installed in correct orientation by checking the locations of the connection terminal and projection portions.

- (4) Securely tighten the two battery unit screws.



CAUTION

- Turn off the power of the gas monitor before replacing the battery unit.
- Detach and reattach the battery unit in a non-hazardous area.
- If the battery unit screw is not completely tightened, the battery unit may drop off or water may get in through the clearance. Water may also get in if a minute foreign substance is caught beneath the battery unit.
- Do not damage the rubber seal.
- To maintain the water-proof and dust-proof performances, it is recommended to replace the rubber seal every two years, whether or not it has an abnormality.

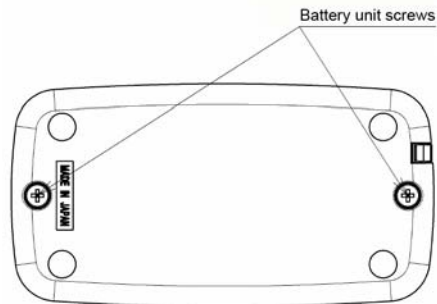
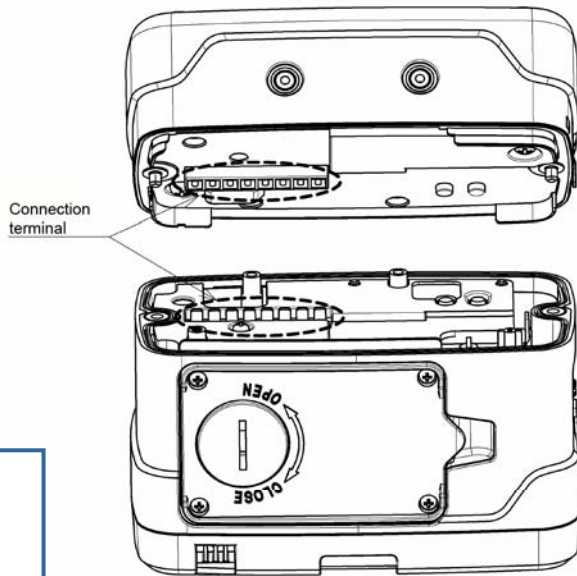

Bottom view

<Connection of Gas Sampling Probe and Gas Sampling Hose>

- Attach the gas sampling probe to the end of the gas sampling hose.
- Connect the sampling hose securely to the gas inlet (GAS IN) of the gas monitor.



Insert the sampling hose to the gas inlet (GAS IN) until it clicks into place to ensure connection.



CAUTION

- Use only a gas sampling hose specified by RIKEN KEIKI.
- Use the gas monitor with the gas sampling probe connected so that no foreign substance is drawn into it.
- Connect a gas sampling probe and a gas sampling hose by fastening them manually without using any tool. If they are fastened too tightly using a tool, the plastic part of the gas sampling probe may be broken.

4-3. Basic operating procedures

Normally, the detection mode is used for normal operations. (The detection mode is activated after the power is turned on.)

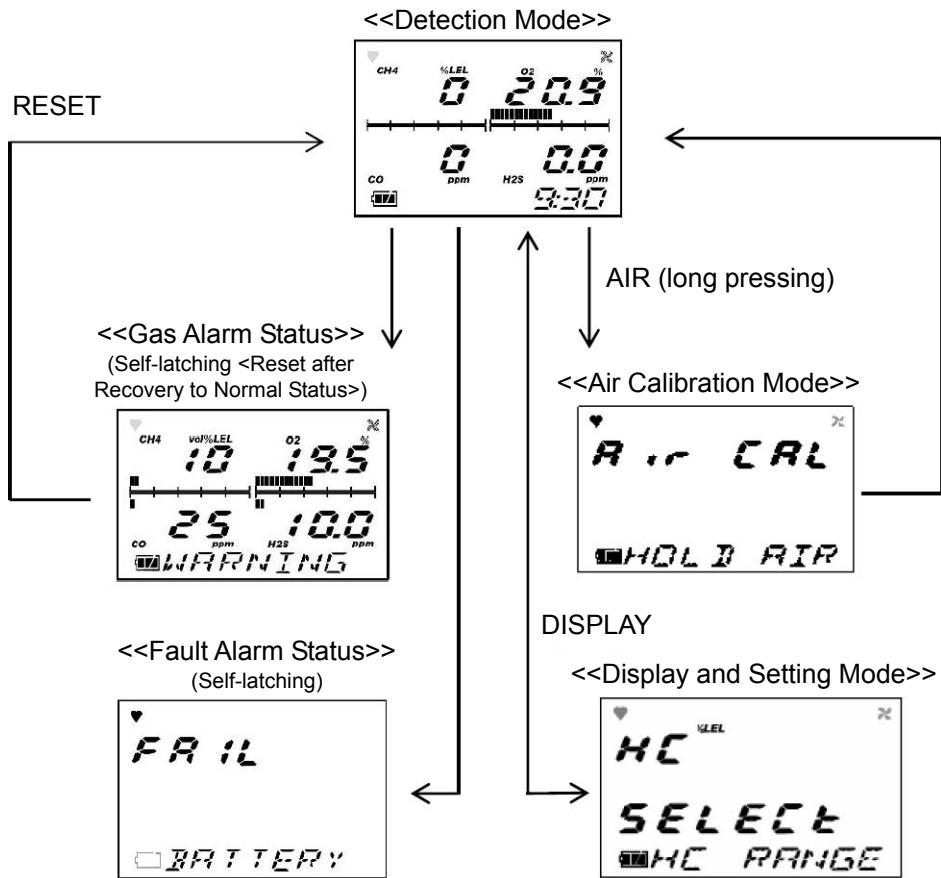

4-4. How to start the gas monitor

<<Start-up Procedure>>

Keep the POWER switch pressed for three seconds or more.



All LCDs light up.

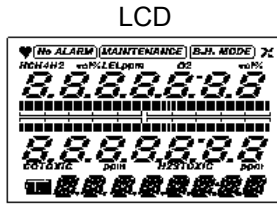

Alarm lamp lights up.
Buzzer sounds once. (Beep)

Date/Time Display

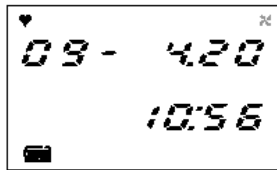

Battery Voltage Display

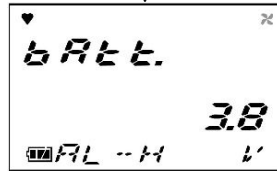

Gas Name Display

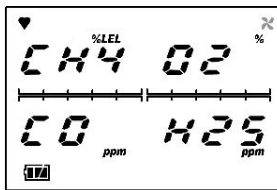

Full Scale Display

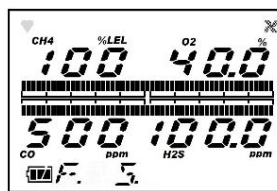

First Alarm Setpoint Display

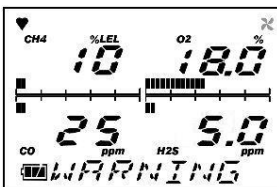

Second Alarm Setpoint Display

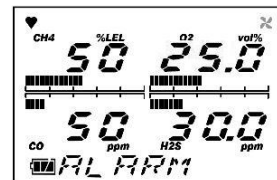

STEL Alarm Setpoint Display

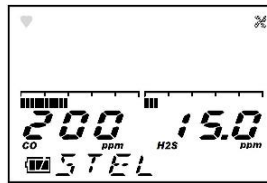

TWA Alarm Setpoint Display

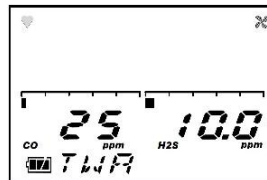

ID Display

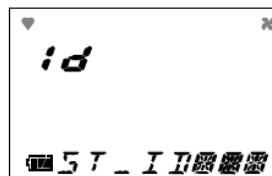

Detection Mode

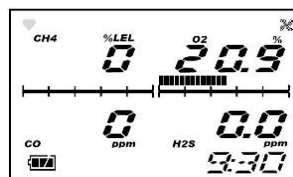

Buzzer sounds twice. (Beep, beep)



CAUTION

After start-up, perform air calibration before performing gas detection (air calibration mode).

NOTE

- A sensor abnormality alarm is issued before the detection mode is entered if there is any abnormality in the sensor. Press the RESET button. This will reset the sensor abnormality alarm temporarily, set the gas concentration display that was abnormal on the sensor to ---, and start gas detection. However, notify the abnormality to RIKEN KEIKI promptly. Gas for which there was an abnormality in the sensor cannot be detected. However, the alarm cannot be reset if there is an abnormality in all the sensors.
- If there is an abnormality in the built-in clock, a fault alarm **FAIL CLOCK** may be issued. Press the RESET button. The fault alarm is temporarily reset, and measurement is started with incorrect clock time.

4-5. How to detect

In the detection mode, put the gas sampling probe close to the detection area and take the reading on the display.

Display example

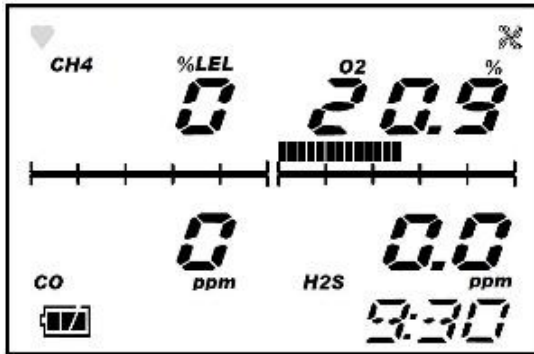

<- Display example

CH4 concentration: 0%LEL

O2 concentration: 20.9%

CO concentration: 0 ppm

H2S concentration: 0 ppm

Time: 9:30

Battery level: Sufficient



DANGER

- While conducting measurement in a manhole or confined space, do not lean over or look into the manhole or closed space. It may lead to dangers because oxygen-deficient air or other gases may blow out.
- Oxygen-deficient air or other gases may blow out from the gas exhausting outlet. Never inhale the air or gases.
- High-concentration (more than LEL) gases may blow out. Never use fire near the gas monitor.



WARNING

- The gas monitor is designed to draw gases around it under the atmospheric pressure. If excessive pressure is applied to the gas inlet and outlet (GAS IN, GAS OUT) of the gas monitor, detected gases may be leaked from its inside, thus leading to dangers. Be sure that excessive pressure is not applied to the gas monitor while used.
- Do not connect the sampling hose directly to a location with a pressure higher than the atmospheric pressure. The internal piping system may be damaged.
- When the fresh air adjustment is performed in the atmosphere, check the atmosphere for freshness before beginning the adjustment. If other gases exist, the adjustment cannot be performed properly, thus leading to dangers when the gas leaks.
- Issuance of a gas alarm indicates that there are extreme dangers. Take proper actions based on your judgment.
- Before use, check that there remains sufficient battery power. When the gas monitor is used for the first time or is not used for a long period, the batteries may be exhausted. Either fully recharge the batteries or replace them with new ones before use.
- If a low battery alarm occurs, gas detection cannot be conducted. If the alarm occurs during use, turn off the power and promptly recharge the batteries in a non-hazardous area.
- Do not block the buzzer sound opening. No alarm sound can be heard.



CAUTION

- Before performing gas detection, attach the gas sampling probe provided with the gas monitor to prevent disturbances by air dust.
- When you measure concentrations of oxygen in inert gases for a long time, the carbon dioxide concentration in the air must be 15% or less. When you use the gas monitor in the air with a carbon dioxide concentration of 15% or higher, perform measurement in as short time as possible. Using the gas monitor under high concentrations for a long time may shorten the life of the oxygen sensor.
- An oxygen concentration higher than a certain level is required for the combustible gas %LEL sensor of the gas monitor to correctly detect gases and display concentrations.
- During combustible gas detection (%LEL range), long-time detection of a high-concentration combustible gas may adversely influence the sensor.
- Use the gas monitor with the LCD display facing upward. The gas monitor, when used with the LCD display in a tilted or flat status, may not display correct values.

NOTE

- If the combustible gas reading exceeds 100% LEL, the CO reading rises temporarily but this is not abnormal.
- In a low-temperature environment, the operating time is shortened due to the battery performance property.
- At a low temperature, the response of the LCD display may get slow down.
- If a combustible gas with a higher concentration than %LEL is drawn, some gas may remain in the gas sampling hose due to adsorption in the hose, gas sampling probe, etc. After drawing a high-concentration combustible gas, clean the gas monitor to remove the adsorbed gas (draw fresh air and check that the reading becomes zero).
Performing fresh air adjustment before cleaning it completely will result in inaccurate adjustment, giving adverse influence on measurement. In such a case, remove the gas sampling hose before performing fresh air adjustment to avoid inaccurate adjustment.
- Perform gas detection in the vol% range (Type-A and E only) in a place where the presence of a high-concentration combustible gas is known.

NOTE

<Influence of Coexisting Gases on High-Concentration Combustible Gas Sensor> (TYPE-A and E Only)

A thermal-conductivity sensor that detects high-concentration combustible gases, based on the principle of detection using a difference in thermal conductivities of gases, may display a reading that is disturbed by a considerable change in the concentration of gases other than the combustible gases that coexist in the atmosphere.

However, the influence of oxygen on readings can be automatically corrected by the sensor, which detects oxygen at the same time, by feeding back a change in the oxygen concentration to the detection result of high-concentration combustible gases.

If coexisting gases other than oxygen undergo a high concentration change, the influence from the change cannot be automatically corrected. This sensor is adjusted to be able to detect high-concentration combustible gases in the air as well as in an nitrogen atmosphere. If the composition of the atmosphere other than nitrogen is known in advance, adjusting the sensor in accordance with the atmosphere can alleviate influences on readings. For information on the adjustment procedure, see the separate "Maintenance Manual."

<Manual Memory>

Any instantaneous value during measurement can be recorded.

Up to 256 points of data can be recorded. When the number of recorded data points reaches the maximum, recorded data will be overwritten, starting from the oldest data.

- (1) In the detection mode, keep the ▼/RESET switch pressed and press the ▲/AIR switch to prepare for recording (about one second). The following screens are displayed in turn on the gas monitor.

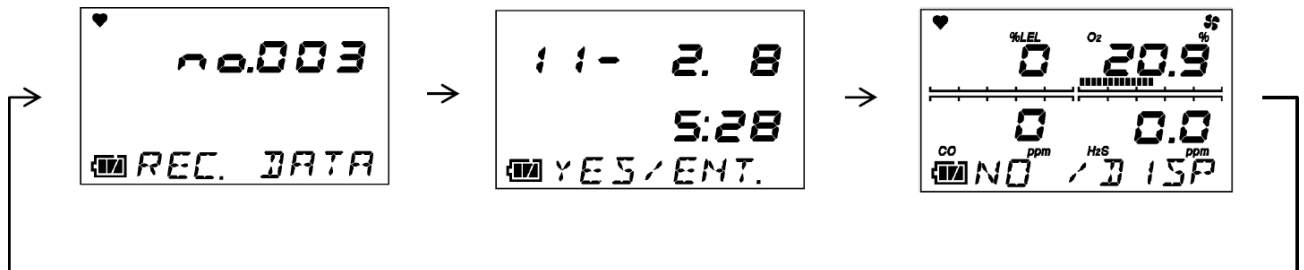

NOTE

The screen displays the memory number, date, and instantaneous value in turn. Go to the next step to execute recording. No value is recorded at this point yet. If you do not want to record a value, press the DISPLAY switch to return to the detection mode.

- (2) Press the ENTER switch. The date and the instantaneous value at the time when the ENTER switch is pressed are recorded.
- (3) When END is displayed, the recording is completed.

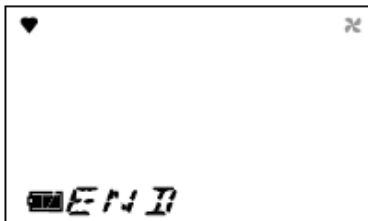

Returns to the detection mode.

<Auto Range Switching Point> (TYPE-A and E Only)

If Auto Range is set on a type with the vol% range for combustible gases, the display is automatically switched to the vol% range when the concentration of a detected combustible gas exceeds 100%LEL. When the concentration drops, the display returns to the %LEL range again. The following shows an example of switching timing.

Diagram of gas concentrations and range switching timing under Auto Range setting

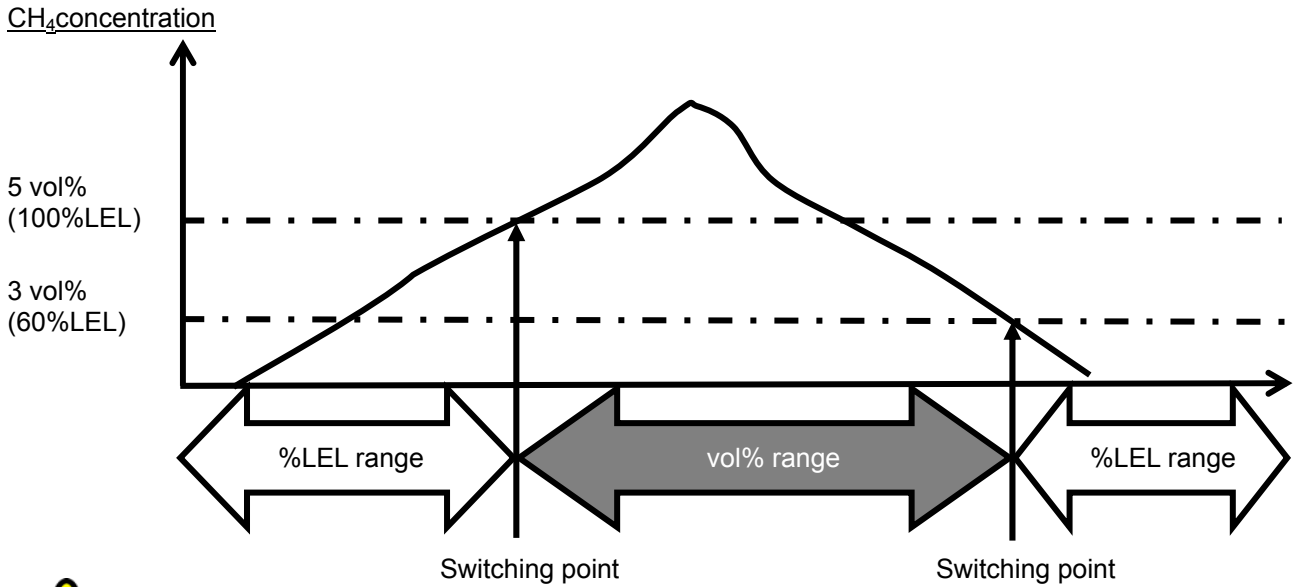







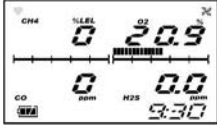
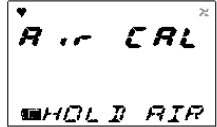

CAUTION

An oxygen concentration higher than a certain level is required for the combustible gas %LEL sensor of the gas monitor to correctly detect gases and display concentrations. For the sake of more accurate gas detection and concentration display, therefore, this gas sensor may perform detection using the vol% sensor if the built-in oxygen sensor of this unit detects an oxygen concentration lower than a certain level in the atmosphere.

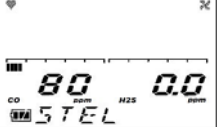
In other words, the display changes at the timing shown above when the oxygen concentration is equal to or higher than a certain level. If it is lower than a certain level, however, the vol% sensor is used for detection even if the combustible gas concentration is lower than the switching point.

4-6. Modes

Details on each mode are provided as follows. (* Operations are slightly different depending on the type.)

Mode	Item	LCD display	Details
Detection Mode	—	Concentration display 	Normal state
Air Calibration Mode	—	AIR CAL 	Perform the zero adjustment.
Display and Setting Mode	Combustible Gas Measurement Range Setting	HC RANGE 	Used to select a combustible gas measurement range manually. (TYPE-A and E only)
	Peak Display	PEAK 	Display the maximum concentration (or minimum concentration for oxygen) detected during measurement from power-on to the present.
	STEL Value Display	STEL 	Display the STEL value after power-on. (TYPE-A, B, C, and D only)
	TWA Value Display	TWA 	Display the TWA value after power-on. (TYPE-A, B, C, and D only)
	Alarm Setpoint Display Alarm Test	ALARM-P 	Display the full scale and alarm setpoint values and check the alarm operations for the settings displayed.
	Pump ON/OFF Setting	PUMP OFF 	Used to turn on/off the pump operations.
	ID Setting	ID SELECT 	Display an ID if it has been set in advance. Also used to change or set an ID.
	Log Data Display	REC.DATA 	Display data recorded to the manual memory.

4-7. Air calibration mode

Press the AIR switch.

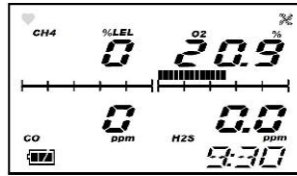

Keep pressing the AIR switch.
Changes the display to Adj -
HOLD AIR.

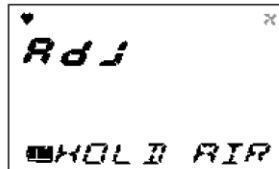
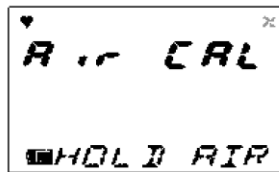

When RELEASE is displayed,
release the AIR switch.
A 30-second countdown is
started on the LCD.
(TYPES-A and E only)



When the zero adjustment is
successfully completed, END
is displayed, and you return
to the detection mode.

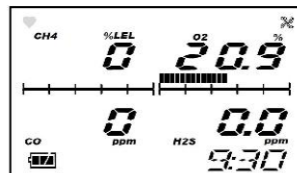

WARNING

When air calibration is performed in the atmosphere, check the atmosphere for freshness before beginning the calibration. If other gases exist, the adjustment cannot be performed properly, thus leading to dangers when the gas leaks.



CAUTION

- Perform air calibration under pressure and temperature/humidity conditions close to those in the operating environment and in fresh air.
- Perform air calibration after the reading is stabilized.
- If there is a sudden temperature change of 15°C or more between the storage and operation locations, turn on the power of the gas monitor, let it leave for about 10 minutes in a similar environment to the operation location, and perform air calibration in fresh air before using it.

NOTE

- Air calibration can be performed even when there is a gas alarm.
- If the air calibration fails, it displays "FAIL" - "AIR CAL" and which sensor has become faulty. Press the RESET button to reset the fault alarm (calibration failure). When the alarm is reset, the value before calibration is displayed.



If CH4 sensor is faulty

4-8. Display/setting mode

This mode allows you to change various displays and settings.
 Every time the DISPLAY switch is pressed, various screens are displayed in turn.
 (* Operations are slightly different depending on the type.)

Detection Mode

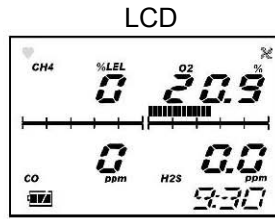

Display and Setting Mode

Combustible Gas Measurement Range Setting

Used to select a combustible gas measurement range manually.
 (TYPE-A and E only)



→ ENTER
 Combustible Gas Measurement Range Setting
 ⇒ P28



PEAK

Display the maximum concentration (or minimum concentration for oxygen) detected during measurement from power-on to the present.

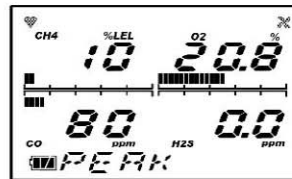

STEL

Display the STEL value after power-on.
 (TYPE-A, B, C, and D only)

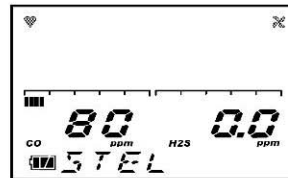

TWA

Display the TWA value after power-on.
 (TYPE-A, B, C, and D only)

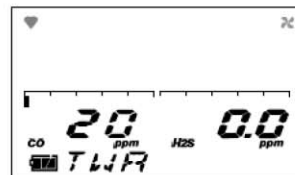

Full Scale Display/Alarm Setpoint Display/Alarm Test

Display the full scale and alarm setpoint values and check the alarm operations for the settings displayed.



→ ENTER
 Full Scale Display/Alarm Setpoint Display/Alarm Test
 ⇒ P30



Pump ON/OFF Setting

Used to turn on/off the pump operations.

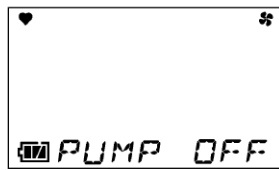

→ Pump ON/OFF Setting
ENTER ⇒ P31

ID Display/Selection

Display an ID if it has been registered in advance. Also used to select an ID.



→ ID Display/Selection
ENTER ⇒ P32

Log Data Display

Display concentration data recorded to the manual memory.



→ Log Data Display
ENTER ⇒ P33

↓
To **Detection Mode**

NOTE

The gas monitor automatically returns to the detection mode in about 20 seconds if the gas monitor is left unoperated.

However, the gas monitor does not automatically return to the detection mode if the pump operation is set to OFF.

<Combustible Gas Measurement Range Setting "HC RANGE"> (TYPE-A and E Only)

The models that can display combustible gas levels in two ways, "%LEL range" and "vol% range," automatically switch between these two displays according to the gas concentration or oxygen concentration, from "%LEL range" to "vol% range" and vice versa. They also support manual selection of measurement range.

- (1) Press the DISPLAY switch and select the combustible gas measurement range setting from the display/setting mode menu.
The following screens are displayed in turn on the gas monitor.



- (2) Press the ENTER switch.

NOTE

If you do not want to make a change, press the DISPLAY switch to return to the display/setting mode menu.

- (3) Every time the ▲ or ▼ switch is pressed, the measurement range menus, AUTO RANGE (automatic switching), ONLY VOL (fixed to the vol% range), and ONLY LEL (fixed to the %LEL range), are displayed in turn.
Press the ▲ or ▼ switch to select a measurement range and press the ENTER switch.



- (4) When END is displayed, the setting is completed.



The display/setting mode menu is displayed again.

- (5) After completion, press the DISPLAY switch several times until it returns to the detection mode.



CAUTION

- No gas alarm is triggered in the combustible gas vol% range-only setting. In the vol% range-only setting, the screen displays [No ALARM] because no alarm is triggered.
- Be careful because the %LEL range-only setting screen does not appear different from the auto range setting screen. Even if the concentration exceeds the full scale, the screen does not automatically switch to the vol% range.

No ALARM display

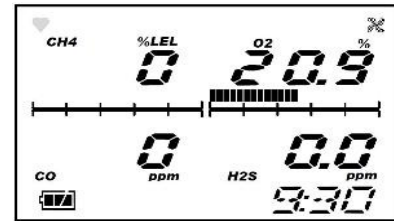
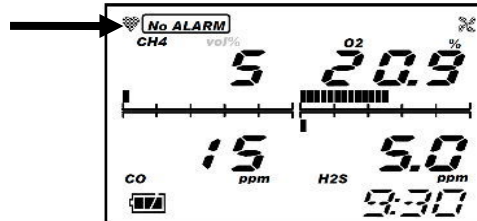

NOTE

During vol% range-only measurement, "vol%" and "No ALARM" displays blink.

<Full Scale Display/Alarm Setpoint Display/Alarm Test "ALARM-P">

Display the full scale or alarm setpoint values and check the alarm operations for the settings displayed.

- (1) Press the DISPLAY switch and select the "full scale display/alarm setpoint display/alarm test" from the display/setting mode menu. The following screens are displayed in turn on the gas monitor.

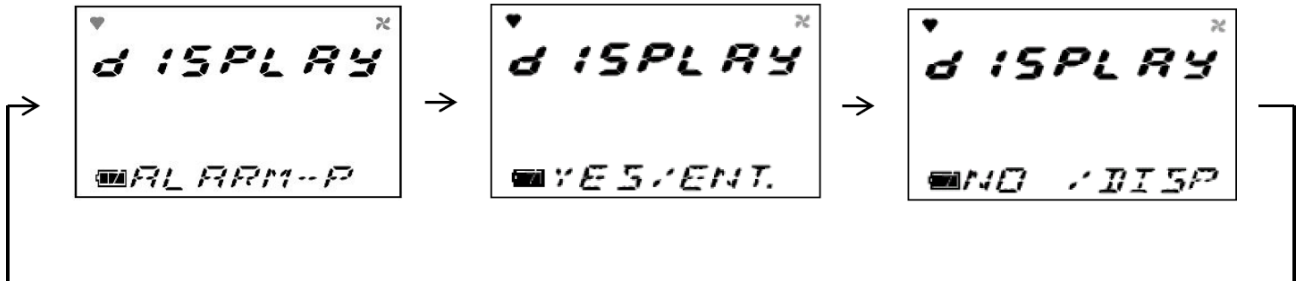

- (2) Press the ENTER switch to enter the alarm setpoint or other display.

NOTE

If you do not want to enter any display, press the DISPLAY switch to return to the display/setting mode menu.

- (3) Every time the ▲ or ▼ switch is pressed, the full scale and alarm setpoint menus, i.e., full scale display, first alarm setpoint display, second alarm setpoint display, STEL alarm setpoint display, and TWA alarm setpoint display, are displayed in turn. Press either the ▲ or ▼ switch to select a setting that you want to check.

Select one of the following screens:

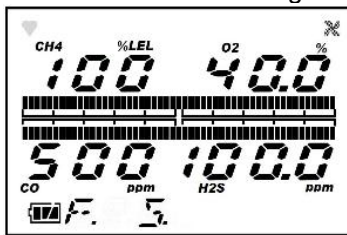

Full Scale Display

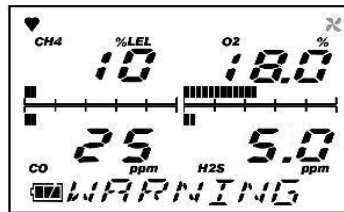

First Alarm Setpoint Display
(WARNING)

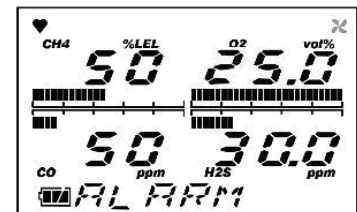

Second Alarm Setpoint Display
(ALARM)

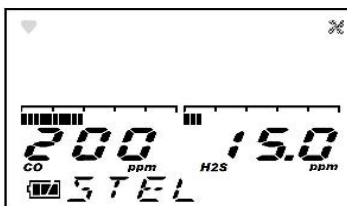

STEL Alarm Setpoint Display (*)

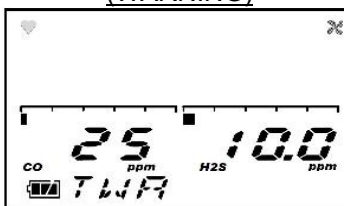

TWA Alarm Setpoint Display(*)

* TYPE-A, B, C, and D only

- (4) Press the ENTER switch to perform alarm test. The alarm operation on this screen can be checked. Press any switch to stop the alarm operation.
- (5) Press the DISPLAY switch to exit the alarm setpoint display or alarm test. The display/setting mode menu is displayed again.
- (6) After completion, press the DISPLAY switch several times until it returns to the detection mode.

<Pump ON/OFF Setting "PUMP OFF">

Used to turn on/off the pump operations.



CAUTION

- While the pump operation is set to OFF, no gas detection is performed because no gas is drawn.
- The gas monitor does not automatically return to the detection mode if the pump operation is set to OFF.

- (1) Press the DISPLAY switch and select the pump ON/OFF setting from the display/setting mode menu. The following screens are displayed in turn on the gas monitor.

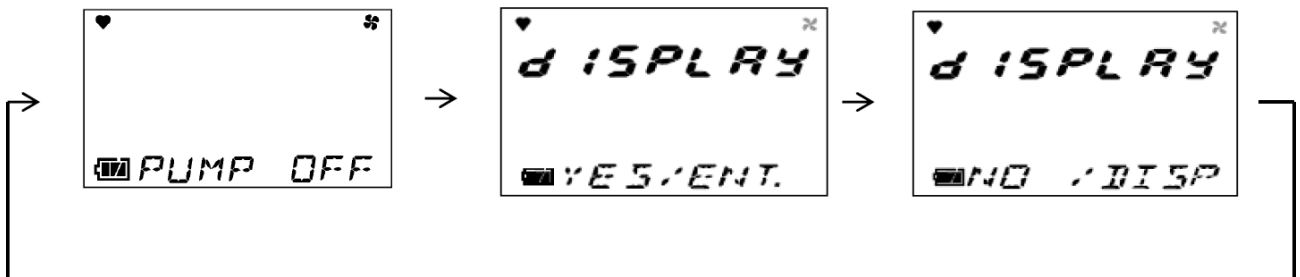

- (2) Press the ENTER switch to set the pump operation to ON or OFF.

NOTE

If you do not want to set the pump operation to ON or OFF, press the DISPLAY switch to return to the display/setting mode menu.

- (3) Every time the ENTER switch is pressed, the pump operation is turned ON or OFF.

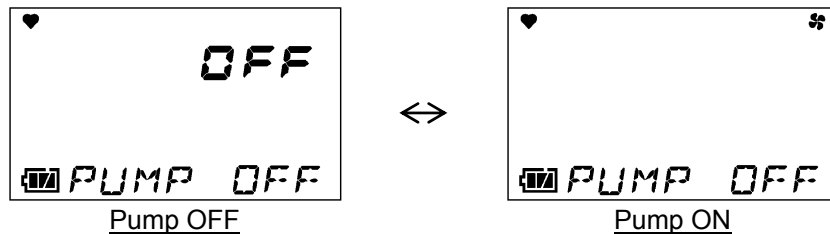

NOTE

While the pump operation is set to OFF, only the ENTER switch is enabled.

- (4) To return to the detection mode, press the ENTER switch to set the pump operation to ON.
- (5) After completion, press the DISPLAY switch several times until it returns to the detection mode.

<ID Display/Selection "ID SELECT">

Display an ID if it has been registered in advance. Also used to select an ID.

- (1) Press the DISPLAY switch and select the ID display/selection from the display/setting mode menu. The following screens are displayed in turn on the gas monitor.



- (2) Press the ENTER switch to set or select an ID.

NOTE

- If you do not want to set or select an ID, press the DISPLAY switch to return to the display/setting mode menu.
- On this gas monitor, either of the IDs from ST-ID000 to ST-ID255 has been registered, unless otherwise specified.
- The data logger management program (option) is required to register or change an ID. Please contact RIKEN KEIKI.

- (3) Press either the ▲ or ▼ switch to select an ID. Every time the ▲ or ▼ switch is pressed, the ID number increases or decreases (000-255).

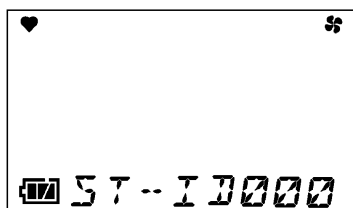

- (4) Press the ENTER switch.
- (5) When END is displayed, the setting is completed.



The display/setting mode menu is displayed again.

- (5) After completion, press the DISPLAY switch several times until it returns to the detection mode.

<Log Data Display "REC.DATA">

Display concentration data recorded to the manual memory.

- Press the DISPLAY switch and select the log data display from the display/setting mode menu. The following screens are displayed in turn on the gas monitor.



- Press the ENTER switch to display the log data.

NOTE

If you do not want to display the log data, press the DISPLAY switch to return to the display/setting mode menu.

- Every time the ▲ or ▼ switch is pressed, the log data menus are displayed in turn. Press either the ▲ or ▼ switch to select log data that you want to check. The log data menu displays the year, month, day, time, and memory number.

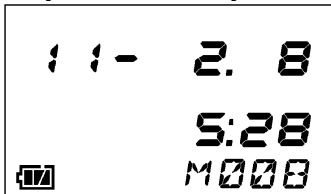

- Press the ENTER switch to display the selected log data.

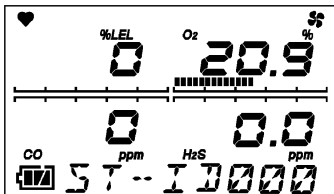

- If you want to display other log data, press the ENTER switch to return to the log data menu. Repeat the steps (3) to (5).
- After completion, press the DISPLAY switch to return to the detection mode.

4-9. How to exit

Make the gas monitor draw in fresh air. After the display returns to zero (or 20.9% for oxygen), keep the POWER/ENTER switch pressed until the power is turned off.

NOTE

If the display is not zero (or 20.9% for oxygen) when the power is turned off, a purge operation may be performed for 30 seconds at the maximum to clean the inside of the gas monitor.



Operations and Functions

5-1. Gas alarm activation

Gas alarm: Triggered when the concentration of detected gas reaches or exceeds the alarm setpoint value. <<Self-latching>>

Alarm display: Notified by blinking of a gas concentration value display, sounding of the buzzer, and lighting of the lamp.

Alarm types: First alarm (WARNING), second alarm (ALARM), OVER alarm, TWA alarm, and STEL alarm

<List of Gas Alarms>

Alarm type	First alarm	Second alarm	OVER alarm	TWA alarm	STEL alarm
Oxygen	18.0% (Japanese specification) 19.5% (Overseas specification)	25.0% (Japanese specification) 23.5% (Overseas specification)	40.0%	—	—
Combustible gas	10%LEL	50%LEL	100%LEL	—	—
Hydrogen sulfide	5.0 ppm	30.0 ppm	100.0 ppm	10.0 ppm	15.0 ppm
Carbon monoxide	25 ppm	50 ppm	500 ppm	25 ppm	200 ppm
Buzzer	Repeatedly sounds strong and weak beeps at about one second intervals: Beep, beep	Repeatedly sounds strong and weak beeps at about 0.5 second intervals: Blip, blip	Repeatedly sounds strong and weak beeps at about 0.5 second intervals: Blip, blip	Repeatedly sounds strong and weak beeps at about one second intervals: Beep, beep	Repeatedly sounds strong and weak beeps at about one second intervals: Beep, beep
Alarm lamp	Repeatedly blinks at about one second intervals.	Repeatedly blinks at about 0.5 second intervals.	Repeatedly blinks at about 0.5 second intervals.	Repeatedly blinks at about one second intervals.	Repeatedly blinks at about one second intervals.
LCD display	Gas concentration and WARNING display blink.	Gas concentration and ALARM display blink.	Gas concentration and OVER display blink.	Gas concentration and TWA display blink.	Gas concentration and STEL display blink.

<Display Operation>

Gas Concentration Display

In a gas alarm, the gas concentration display and the alarm type display blink.

In case of over the detection range (Over Scale), "〇〇〇" is displayed on the LCD.

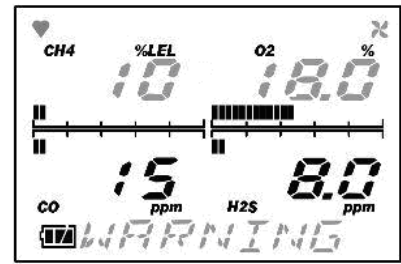

Display example

Alarm Lamp

The alarm consists of two steps. Each of them is triggered when the respective alarm setpoint value is reached to or exceeded.

Buzzer

The alarm consists of two steps. Each of them sounds when the respective alarm setpoint value is reached to or exceeded.

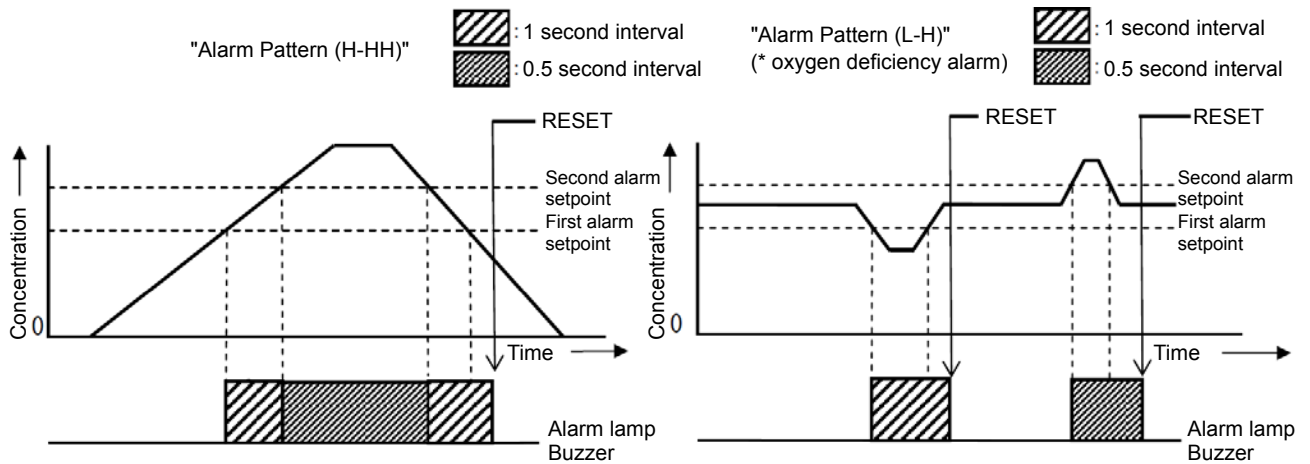

WARNING

Issuance of a gas alarm indicates that there are extreme dangers. Take proper actions based on your judgment.

5-2. Fault alarm activation

Fault alarm: Triggered when an abnormality is detected in the gas monitor. <<Self-latching>>

Alarm display: Notified by display of error messages, sounding of the buzzer, and lighting of the lamp.

Alarm types: Low flow rate, sensor abnormality, battery voltage low, system abnormality, and calibration failure

Determine the causes and take appropriate actions.

If the gas monitor has problems and is repeatedly malfunctioning, contact RIKEN KEIKI immediately.

<Display Operation>

LCD display	Displays an error message.
Alarm lamp	Repeatedly blinks at about one second intervals.
Buzzer	Repeatedly sounds intermittent beeps at about one second intervals: Blip, beep, blip, beep



Display example

NOTE

- To reset a low flow rate alarm (FAIL LOW FLOW), remove the cause of the low flow rate, and then press the RESET switch.
- For information on malfunctions (error messages), see "8. Troubleshooting".

5-3. Other functions

<Calibration History/Various Trend/Event History Functions>

The gas monitor has history and trend functions. To use these functions, contact RIKEN KEIKI.

NOTE

The data logger management program (option) is required to use the history and trend functions. Please contact RIKEN KEIKI.

Maintenance

This is an important instrument for the purpose of safety.

To maintain the performance of the gas monitor and improve the reliability of safety, perform a regular maintenance.

6-1. Maintenance intervals and items

- Daily maintenance: Perform maintenance before beginning to work.
- Monthly maintenance: Perform alarm test once a month.
- Regular maintenance: Perform a maintenance once or more for every six months to maintain the performance as a safety unit.

Maintenance item	Maintenance content	Daily maintenance	Monthly maintenance	Regular maintenance
Battery Level Check	Check that the battery level is sufficient.	○	○	○
Concentration Display Check	Make the gas monitor draw in fresh air and check that the concentration display value is zero (or 20.9 vol% on the oxygen deficiency meter). When the reading is incorrect, perform the zero adjustment (fresh air adjustment) after ensuring that no other gases exist around it.	○	○	○
Flow Rate Check	See the flow rate indicator to check for abnormalities.	○	○	○
Filter Check	Check the dust filter for dust or clogging.	○	○	○
Alarm Test	Check the alarm lamp and buzzer for normal operation using the alarm test function.		○	○
Span Adjustment	Perform the span adjustment by using the calibration gas.			○
Gas Alarm Check	Check the gas alarm by using the calibration gas.			○

<About Maintenance Services>

- We provide services on regular maintenance including span adjustment, other adjustments and maintenance.
To make the calibration gas, dedicated tools, such as a gas cylinder of the specified concentration and gas sampling bag must be used.
Our qualified service engineers have expertise and knowledge on the dedicated tools used for services, along with other products. To maintain the safety operation of the gas monitor, please use our maintenance service.
- The followings are typical maintenance services. For more information, please contact RIKEN KEIKI.

Main Services

Battery Level Check	: Checks the battery level.
Concentration Display Check	: Verifies that the concentration display value is zero (or 20.9 vol% on the oxygen deficiency meter) by using the zero gas. Performs the zero adjustment (fresh air adjustment) if the reading is incorrect.
Flow Rate Check	: Checks the flow rate indicator to find abnormalities. Checks the flow rate by using an external flow meter to verify the correctness of the flow rate indicator on the gas monitor. If the flow rate is incorrect, performs the flow rate adjustment.
Filter Check	: Checks the dust filter for dust or clogging. Replaces a dirty or clogged dust filter.
Alarm Test	: Checks the alarm lamp and buzzer for normal operation using the alarm test function.
Span Adjustment	: Performs the span adjustment by using the calibration gas.
Gas Alarm Check	: Checks the gas alarm by using the calibration gas. <ul style="list-style-type: none">• Checks the alarm. (Checks the alarm activation when the alarm setpoint is reached.)• Checks the delay time. (Checks time to delay until the alarm is triggered.)• Checks the buzzer, lamp, and concentration display. (Check each activation of ALM1 and ALM2.)
Cleaning and Repair of Gas Monitor (visual diagnosis)	: Checks dust or damage on surface of the gas monitor, clean and repair such parts of the gas monitor. Replaces parts which are cracked or damaged.
Gas Monitor Operation Check	: Uses the keys to check the operation of functions and parameters.
Replacement of Consumable Parts	: Replaces consumable parts, such as a sensor, filter and pump.

6-2. Gas calibration method

Perform span adjustment of sensors using a calibration gas at least once every six months. The span adjustment requires dedicated equipment and a calibration gas. Request RIKEN KEIKI for it. If you perform the span adjustment for yourself, prepare these tools in advance and perform the adjustment in accordance with the "Maintenance Manual."



CAUTION

Do not use a lighter gas to check the sensitivity of the gas monitor. A constituent of the lighter gas may deteriorate the sensor performances.

6-3. How to clean

Clean the gas monitor if it becomes extremely dirty. The gas monitor must be turned off while cleaning it. Use a waste cloth to remove dust. Do not use water or organic solvent for cleaning because they may cause malfunctions.

Because an extremely large amount of dust inside the gas sampling hose may disturb the gas detection, it must be cleaned with dry AIR, etc.



CAUTION

When cleaning the gas monitor, do not splash water over it or use organic solvents such as alcohol and benzene on it. The surface of the gas monitor may be discolored or damaged.

NOTE

When the gas monitor gets wet, water may remain in the buzzer sound opening or clearances. Drain water as follows:

- (1) Wipe away moisture on the gas monitor thoroughly using a dry towel, cloth, etc.
- (2) While holding the gas monitor firmly, shake it about ten times with the buzzer sound opening facing downward.
- (3) Wipe away moisture coming out from the inside thoroughly using a towel, cloth, etc.
- (4) Place the gas monitor on a dry towel, cloth, etc. and let it stand at normal temperatures.

6-4. Parts replacement

<Replacement of Consumables>

Sensor Replacement

The built-in sensors of the gas monitor have a validity period and must be replaced regularly. The sensor life has expired if, for example, the sensors cannot be calibrated in span adjustment, the readings do not come back after fresh air adjustment, or the readings fluctuate. Contact RIKEN KEIKI. The warranty period is one year for all the sensors.

Dust Filter Replacement Procedure

Because the dust filter may gradually get dirty or clogged over the time, it must be replaced regarding the operating conditions. Check the dust filter, and then replace it as necessary. The gas monitor has various built-in filters.

Gas sampling probe

The gas sampling probe has a built-in Teflon filter. Replace the filter when it has absorbed water, has a low flow rate, or looks significantly contaminated.

- (1) Hold the transparent part and turn the tip (white) to remove it.
- (2) Take out the filter from the transparent part and insert a new filter.



CAUTION

Make sure that the filter is inserted in correct orientation.

- (3) Attach the tip that has been removed.



Replacement



How to replace the activated carbon filter



CAUTION

- Turn off the power of the gas monitor before replacing the activated carbon filter.
- Do not remove the activated carbon filter knob unless the activated carbon filter is to be replaced. If the activated carbon filter knob is loose (not sufficiently tightened), accurate measurement may not be possible due to leaks, or water may get inside.
- No activated carbon filter is used on a type that does not measure carbon monoxide. Keep this knob tightened at all times.
- Use only an activated carbon filter dedicated to the gas monitor (GX-8000). Using a similar product may have harmful effects on the gas detection performance.

- (1) Using a coin, etc., turn the activated carbon filter knob counterclockwise (in a direction indicated as OPEN in this figure) to remove it.

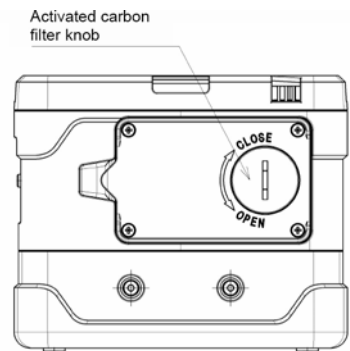

- (2) Pull out to remove the filter case from the activated carbon knob.



- (3) Replace the two activated carbon filters in the filter case with new ones.

- (4) Attach the filter case to the activated carbon filter knob and put it as far as it will go.

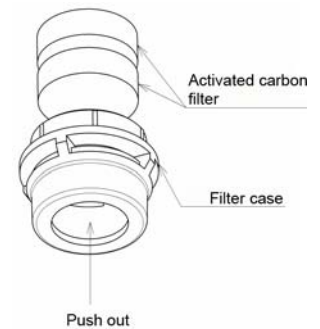

- (5) Attach the activated carbon filter knob to the main unit in an opposite procedure to Step (1). Tighten it firmly using a coin, etc.



CAUTION

If the knob is not completely tightened, accurate gas measurement may not be possible due to leaks, or water may get inside. The same thing occurs if a minute foreign substance is caught beneath the knob.

<Replacement of Regular Replacement Parts>

List of recommended regular replacement parts

No.	Item	Maintenance intervals	Replacement intervals	Quantity (pieces per unit)	Remarks
1	Rubber seal	—	2 years	1 set	
2	Tube	6 months	3 - 8 years	1 set	
3	Pump unit (RP-11)	6 months	1 - 2 years	1	
4	Li-ion battery pack (BP-8000)	—	—	1	About 500 cycles of charging and discharging

NOTE

The above replacement intervals are recommendation only. The intervals may change depending on the operating conditions. These intervals do not mean the warranty periods either. The result of the regular maintenance may determine when to replace the parts.

The operation of most of the periodical replacement parts must be checked after replacement by a qualified service engineer.

For the stable operation of the gas monitor and safety, ask a qualified service engineer to take care of replacement of the parts whose operation must be checked. Please contact RIKEN KEIKI.

Storage and Disposal

7-1. Procedures to store the gas monitor or leave it for a long time

The gas monitor must be stored under the following environmental conditions.

- In a dark place under the normal temperature and humidity away from direct sunlight
- In a place where gases, solvents or vapors are not present

Store the gas monitor in a shipping carton, if any, in which the product was delivered.
Store the gas monitor away from dust, etc. if the shipping carton is not available.



CAUTION

If the gas monitor is not used for a long time, turn on the power at least once every six months and check that the pump draws in air (about three minutes). The gas monitor, when not activated for a long time, may cease to work because of hardening of the grease in the pump motor.

NOTE

- If the gas monitor with a Li-ion battery unit is not used for a long time, it is recommended to store it after discharging the batteries until the battery level icon shows one battery mark or so. If the gas monitor is stored with the batteries fully recharged, the batteries get deteriorated more quickly and may have shorter life.
- If the gas monitor with a dry battery unit is not used for a long time, store it after removing the batteries. Battery leaks may result in fire or injury. If the gas monitor is not used for a short time, store it without removing the batteries. While the power of the gas monitor is OFF, the sensor is energized at all times. Therefore, it is necessary to store the gas monitor with the batteries in it.

7-2. Procedures to use the gas monitor again



CAUTION

When you use a stopped/stored gas monitor again, do not forget to perform a gas calibration. For information on readjustment including gas calibration, please contact RIKEN KEIKI.

7-3. Disposal of products



WARNING

- Do not disassemble the electrochemical type sensor or galvanic cell type sensor because they contain electrolyte. Electrolyte may cause severe skin burns if it contacts skin, while it may cause blindness if it contacts eyes.
If electrolyte is adhered on you clothes, that part on your clothes is discolored or its material is decomposed. If contact occurs, rinse the area immediately with a large quantity of water.
- Dispose of the batteries in accordance with procedure specified by the local authority.

Troubleshooting

The troubleshooting does not explain the causes of all the malfunctions which occur on the gas monitor. This simply helps to find the causes of malfunctions which frequently occur. If the gas monitor shows a symptom which is not explained in this manual, or still has malfunctions even though remedial actions are taken, please contact RIKEN KEIKI.

<Abnormalities on Unit>

Symptoms	Causes	Actions
<u>The power cannot be turned on.</u>	The battery level is too low.	Li-ion battery unit: Recharge the batteries in a non-hazardous area. Dry battery unit: Replace all the three dry batteries with new ones in a non-hazardous area.
	The power switch was not pressed long enough.	For power-on, keep the POWER switch pressed until a beep is heard (about two seconds).
	Improper installation of the power supply unit	Check whether the power supply unit is properly attached to the main unit.
<u>Abnormal operations</u>	Disturbances by sudden surge noise, etc.	Turn off and restart the gas monitor.
<u>Key operations are disabled.</u>	Disturbances by sudden surge noise, etc.	In a non-hazardous area, remove the battery unit once, and reinstall the battery unit, and turn on the power to perform operations.
<u>System abnormalities</u> <u>FAIL SYSTEM</u>	A circuit abnormality occurred.	Request RIKEN KEIKI for repair.
<u>System abnormalities</u> <u>FAIL SYSTEM</u> Error No.000	Abnormalities of internal ROM	Request RIKEN KEIKI for repair.
Error No.010	Abnormalities of internal RAM	
Error No.021	Abnormalities of internal FRAM	
Error No.031	Abnormalities of internal FLASH	
<u>Sensor abnormalities</u> <u>FAIL SENSOR</u>	A sensor has failed.	Request RIKEN KEIKI to replace the sensor. (Only at power-on, press the RESET switch to continue the operation using only the normal sensors to detect other gases.)
<u>A low battery voltage alarm is displayed.</u> <u>FAIL BATTERY</u>	The battery level is low.	Li-ion battery unit: Turn off the power and recharge it in a non-hazardous area.
		Dry battery unit: Turn off the power and replace the dry batteries with new ones in a non-hazardous area.

Symptoms	Causes	Actions
<u>A low flow rate alarm is displayed.</u> <u>FAIL LOW FLOW</u>	Water or oil, etc. was drawn in.	Check the gas sampling hose for any damage or mark of drawn water or oil, etc.
	The gas sampling hose is clogged.	Check the gas sampling hose for connections, clogging, twisting, etc.
	The pump has deteriorated.	Request RIKEN KEIKI to replace the pump.
<u>Fresh air adjustment cannot be performed.</u> <u>FAIL AIR CAL</u>	Fresh air is not supplied around the gas monitor.	Supply fresh air.
<u>Clock abnormalities</u> <u>FAIL CLOCK</u>	Abnormalities of the internal clock	Make a setting of Date/Time. If such a symptom is observed repeatedly, the built-in clock is seemingly malfunctioning. Thus, it must be replaced. Please contact RIKEN KEIKI.
<u>The batteries cannot be recharged.</u> <u>(Li-ion battery unit only)</u>	The charger is not connected properly.	Connect the AC powered charger to the wall electric outlet and jack properly.
	A recharging circuit abnormality occurred.	Request RIKEN KEIKI for repair.
	The batteries have been fully charged.	When fully recharged batteries are recharged again, the recharging indicator lamp does not go on.

<Abnormalities of Readings>

Symptoms	Causes	Actions
<u>The reading rises (drops) and it remains so.</u>	Drifting of sensor output	Perform the zero adjustment (fresh air adjustment).
	Presence of interference gas	Disturbances by interference gases, such as solvents, cannot be eliminated completely. For information on actions, such as removal filter, please contact RIKEN KEIKI.
	Slow leak	A very small amount of the gas to be detected may be leaking (slow leak). Because ignoring it may cause dangers, take a remedial measure, i.e., taking actions the same as those for the gas alarm.
	Environmental changes	Perform the zero adjustment (fresh air adjustment). In particular, the galvanic cell type is affected by the air pressure.
<u>A gas alarm is triggered despite of no gas leak and no other abnormalities at the detection point.</u>	Presence of interference gas	Disturbances by interference gases, such as solvents, cannot be eliminated completely. For information on actions, such as removal filter, please contact RIKEN KEIKI.
	Disturbance by noise	Turn off and restart the gas monitor. If such a symptom is observed frequently, take appropriate measures to eliminate the noise.
<u>Slow response</u>	Clogged dust filter	Replace the dust filter.
	Bended or clogged suction tube or exhaust tube	Fix the defective parts.
	Condensation is formed inside the suction tube.	Fix the defective parts.
	Deteriorated sensor sensitivity	Replace the sensor unit with a new one.
<u>Span adjustment impossible</u>	Improper calibration gas concentration	Use the proper calibration gas.
	Deteriorated sensor sensitivity	Replace the sensor unit with a new one.

Product Specifications

9-1. List of specifications

<Japanese Specifications>

Model	GX-8000			
Detection principle	Galvanic cell (OS)	New ceramic catalytic(NC)/ Thermal conductivity(TE)	Electrochemical (ES)	Electrochemical (ES)
Detectable gas	Oxygen (O ₂)	Combustible gas (HC/CH ₄ /H ₂)	Hydrogen sulfide (H ₂ S)	Carbon monoxide (CO)
Measuring range <Service range>	0~25vol% <~40vol%>	0~100%LEL/~100vol%	0~30ppm <~100ppm>	0~150ppm <~500ppm>
Resolution	0.1vol%	1%LEL/1vol%	0.5ppm	1ppm
Alarm preset point	18vol%(L) 25vol%(H) 40vol%(OVER)	10%LEL(1st) 50%LEL(2nd) 100%LEL(OVER)	5ppm(1st) 30ppm(2nd) 10ppm(TWA) 15ppm(STEL) 100ppm(OVER)	25ppm(1st) 50ppm(2nd) 25ppm(TWA) 200ppm(STEL) 500ppm(OVER)
Indicate accuracy (under an identical condition)	Less than±0.7vol%	Less than±5%LEL(NC)/ Less than±5vol%(TE)	Less than±1.5ppm	Less than±15ppm
Response time (under an identical condition)	Less than 20sec(T90)	Less than 30sec(T90)	Less than 30sec(T90)	Less than 30sec(T90)
Alarm accuracy (under an identical condition)	Less than±1vol%	Less than±25%	Less than±3ppm	Less than±30%
Alarm-delay time (under an identical condition)	Less than 5sec	Less than 30sec	Less than 15sec	Less than 30sec
Gas concentration display	LCD(digital)			
Detection method	Pump suction method			
Suction flow	Above 0.75L/min(open flow)			
Various indications	Clock/Battery condition/Pilot indicator/Flow indicator			
Alarm sound	Above 95dB(A)(30cm)			
Gas alarm indication	Lamp blinking/Intermittent buzzer/Gas concentration display blinking			
Gas alarm action	Latched			
Trouble alarm· Self diagnosis	System failure/Sensor failure/Low battery/Calibration failure/Flow failure			
Trouble alarm indication	Lamp lighting/Intermittent buzzer/Content display			
Trouble alarm action	Auto-recover			
Specification of transmission	IrDA			
Various functions	LCD backlight/Data logger/Peak hold/Logged data display/Pump stop			
Power supply	Lithium ion battery unit 【BUL-8000(G)】 (Dedicated dry battery unit<three AA batteries>【BUD-8000(G)】 is available.)			
Continuous operation Time	BUL-8000(G): Approx. 12 hours(25°C·Non alarm operation·After full charge) BUD-8000(G): Approx. 6 hours(25°C·Non alarm operation)			
Operating temperature	-20~50°C			
Operating humidity	Less than 95%RH(non-condensing)			
Structure	Dust and Water-proof Structure(IP67)			
Explosion-proof structure	Intrinsically safe structure			
Explosion-proof grade	Exia II CT4X(TIIS< Japan>)			
Explosion-proof approval No.	TC19439(TIIS< Japan>)			
Outer dimension	Approx. 154(W)×81(H)×127(D)mm(projection excluding)			
Weight	Approx. 1.1kg(BUL-8000(G) when in use)/Approx. 1.0kg(BUD-8000(G) when in use)			

<Overseas Specifications>

Model	GX-8000			
Detection principle	Galvanic cell (OS)	New ceramic catalytic(NC)/ Thermal conductivity(TE)	Electrochemical (ES)	Electrochemical (ES)
Detectable gas	Oxygen (O ₂)	Combustible gas (HC/CH ₄ /H ₂)	Hydrogen sulfide (H ₂ S)	Carbon monoxide (CO)
Measuring range <Service range>	0~25vol% <~40vol%>	0~100%LEL/~100vol%	0~30ppm <~100ppm>	0~150ppm <~500ppm>
Resolution	0.1vol%	1%LEL/1vol%	0.5ppm	1ppm
Alarm preset point	19.5vol%(L) 23.5vol%(H) 40vol%(OVER)	10%LEL(1st) 50%LEL(2nd) 100%LEL(OVER)	5ppm(1st) 30ppm(2nd) 10ppm(TWA) 15ppm(STEL) 100ppm(OVER)	25ppm(1st) 50ppm(2nd) 25ppm(TWA) 200ppm(STEL) 500ppm(OVER)
Indicate accuracy (under an identical condition)	Less than±0.7vol%	Less than±5%LEL(NC)/ Less than±5vol%(TE)	Less than±1.5ppm	Less than±15ppm
Response time (under an identical condition)	Less than 20sec(T90)	Less than 30sec(T90)	Less than 30sec(T90)	Less than 30sec(T90)
Gas concentration display	LCD(digital)			
Detection method	Pump suction method			
Suction flow	Above 0.75L/min(open flow)			
Various indications	Clock/Battery condition/Pilot indicator/Flow indicator			
Alarm sound	Above 95dB(A)(30cm)			
Gas alarm indication	Lamp blinking/Intermittent buzzer/Gas concentration display blinking			
Gas alarm action	Latched			
Trouble alarm· Self diagnosis	System failure/Sensor failure/Low battery/Calibration failure/Flow failure			
Trouble alarm indication	Lamp lighting/Intermittent buzzer/Content display			
Trouble alarm action	Auto-recover			
Specification of transmission	IrDA			
Various functions	LCD backlight/Data logger/Peak hold/Logged data display/Pump stop			
Power supply	Lithium ion battery unit 【BUL-8000(G)】 (Dedicated dry battery unit<three AA batteries>【BUD-8000(G)】 is available.)			
Continuous operation Time	BUL-8000(G): Approx. 12 hours(25°C·Non alarm operation·After full charge) BUD-8000(G): Approx. 6 hours(25°C·Non alarm operation)			
Operating temperature	-20~50°C			
Operating humidity	Less than 95%RH(non-condensing)			
Structure	Dust and Water-proof Structure(IP67)			
Explosion-proof structure	Intrinsically safe structure			
Explosion-proof grade	II 1 G Ex ia II C T4 Ga(ATEX/IECEX<KEMA>)			
Explosion-proof approval No.	KEMA10ATEX0085(ATEX)/IECEXKEM10.0038(IECEX)			
Outer dimension	Approx. 154(W)×81(H)×127(D)mm(projection excluding)			
Weight	Approx. 1.1kg(BUL-8000(G) when in use)/Approx. 1.0kg(BUD-8000(G) when in use)			

<Combinations of Detected Gases by Type>

TypeA	Oxygen (O ₂)	Combustible (HC and CH ₄) *	Hydrogen sulfide (H ₂ S)	Carbon monoxide (CO)
TypeB	Oxygen (O ₂)	Combustible (HC and CH ₄)	Hydrogen sulfide (H ₂ S)	Carbon monoxide (CO)
TypeC	Oxygen (O ₂)	Combustible (HC and CH ₄)	Hydrogen sulfide (H ₂ S)	
TypeD	Oxygen (O ₂)	Combustible (HC and CH ₄)		Carbon monoxide (CO)
TypeE	Oxygen (O ₂)	Combustible (HC, CH ₄ , and H ₂) *		
TypeF	Oxygen (O ₂)	Combustible (HC, CH ₄ , and H ₂)		

* Range: 0 to 100%LEL(NC)/to 100 vol%(TE) specifications. Only 0 to 100%LEL(NC) for other combustible gases.

9-2. List of accessories

Standard accessories	<ul style="list-style-type: none"> • Li-ion battery unit (BUL-8000 (G)) • AC powered charger • Shoulder strap • Gas sampling hose (1 m spiral) • Gas sampling probe
Optional accessories	<ul style="list-style-type: none"> • Dry battery unit (BUD-8000 (G)) • Waist strap • Waist strap fixing tool • Carrying case (leather) • Aluminum trunk case • Shipboard storage box (metal) • Sampling probe holder • Gas sampling hose (with float probe, 8m) • Gas sampling hose 30 m with plummet • Filter tube • Filter tube fixing belt • Water trap • Relay tube • Set of gas bags (LEL/VOL) • Span cans (CALGAS 4 component mixed gas) • Demand flow valve • Data logger management program

Definition of Terms

vol%	Gas concentration indicated in the unit of one-hundredth of the volume
ppm	Gas concentration indicated in the unit of one-millionth of the volume
%LEL	An abbreviation for "Lower Explosion Limit." LEL refers to the lowest concentration of a combustible gas in air capable of causing explosion when ignited.
TWA	An abbreviation for "Threshold Limit Value Time Weighted Average Limit." TWA refers to a concentration limit of toxic substances as a time weighted average to which repetitious exposure of almost all the workers in 8-hour work shift or a 40-hour work week does not have harmful effects on their health.
STEL	An abbreviation for "Threshold Limit Value Short Term Exposure Limit." STEL refers to a concentration limit of toxic substances to which everyday exposure of workers for 15 continuous minutes lower than TWA does not have harmful effects on their health.