



INSTRUMENTS

SC-01

Operator's Manual

Part Number: 71-0136RK

Revision: P3

Released: 9/26/07

www.rkiinstruments.com

Warranty

RKI Instruments, Inc., warrants the SC-01 Single Gas Monitor sold by us to be free from defects in materials, workmanship, and performance for a period of one(1) year from the date of shipment from RKI Instruments, Inc. This includes the instrument and the original sensor. Replacement parts are warranted for one (1) year from the date of their shipment from RKI Instruments, Inc. Any parts found defective within their warranty period will be repaired or replaced, at our option, free of charge. This warranty does not apply to those items, which by their nature, are subject to deterioration or consumption in normal service, and which must be cleaned, repaired, or replaced on a routine basis. Examples of such items are as follows:

Absorbent cartridges

Filter elements, disks, or sheets

Pump diaphragms and valves

Warranty is voided by abuse including mechanical damage, alteration, rough handling, or repair procedures not in accordance with the instruction manual. This warranty indicates the full extent of our liability, and we are not responsible for removal or replacement costs, local repair costs, transportation costs, or contingent expenses incurred without our prior approval.

THIS WARRANTY IS EXPRESSLY IN LIEU OF ANY AND ALL OTHER WARRANTIES AND REPRESENTATIONS, EXPRESSED OR IMPLIED, AND ALL OTHER OBLIGATIONS OR LIABILITIES ON THE PART OF RKI INSTRUMENTS, INC., INCLUDING BUT NOT LIMITED TO THE WARRANTY OF MERCHANTABILITY OR FITNESS FOR A PARTICULAR PURPOSE. IN NO EVENT SHALL RKI INSTRUMENTS, INC., BE LIABLE FOR INDIRECT, INCIDENTAL, OR CONSEQUENTIAL LOSS OR DAMAGE OF ANY KIND CONNECTED WITH THE USE OF ITS PRODUCTS OR FAILURE OF ITS PRODUCTS TO FUNCTION OR OPERATE PROPERLY.

This warranty covers instruments and parts sold to users only by authorized distributors, dealers, and representatives as appointed by RKI Instruments, Inc.

We do not assume indemnification for any accident or damage caused by the operation of this gas monitor and our warranty is limited to replacement of parts or our complete goods.

Table of Contents

Introduction	5
Specifications	6
Description	7
Protective Rubber Boot	8
Case	8
Alligator & Belt Clips	9
Sensor Retainer	9
Sensor	10
LCD	10
Control Buttons	10
Printed Circuit Boards	11
Alarm LEDs	11
Buzzer	11
Vibrator	11
Batteries	12
Start Up	13
Start-up Procedure	13
Performing a Fresh Air Adjustment	14
Turning Off the SC-01	15
Operation in Measuring Mode	16
Normal Operation	16
Display Mode	16
Alarms	17
Using the SC-01 With the Optional Extender Cable	21
Data Logging	24
Setup Mode	25
Using Setup Mode	25
Setting the Date and Time	25
Performing a Fresh Air Adjustment	26
Performing a Span Adjustment	27
Updating the Alarm Point Settings	30
Updating the Calibration Frequency	33
Entering Measuring Mode	33

Maintenance	34
Calibration	34
Troubleshooting	34
Replacing the Batteries	36
Replacing the Sensor	37
Changing the SC-01s Target Gas	40
Parts List	41

WARNING: Understand this manual before operating the 01 Series. Substitution of components may impair intrinsic safety. To prevent ignition of a hazardous atmosphere, batteries must only be changed in an area known to be nonhazardous. This unit has not been tested in an oxygen enriched atmosphere (above 21%).

Introduction

Using an advanced microprocessor controlled detection system, the SC-01 Personal Single Gas Monitor detects the presence of one of a variety of toxic gasses depending on the sensor installed. The SC-01 has the ability to recognize which sensor is installed so that changing the target gas is as easy as changing the sensor to a different type calibrated sensor. The SC-01's compact size and easy-to-use design makes it ideally suited for a wide range of applications, including sewage treatment plants, hazardous waste sites, petrochemical facilities, oil fields, chemical plants, and semiconductor plants. The SC-01 offers the following features:

- Sensor recognition for plug & play capability
- Available extender cable for remote sensor capability
- Compact design
- Fast, accurate response with digital liquid crystal display (LCD)
- Visual, audible, and vibration alarms
- Microprocessor control for reliability, ease of use, and advanced capabilities
- Peak, STEL, and TWA indication
- Data Logging
- Over range alarm
- Gas, battery, sensor failure, and system failure alarms
- Over 250 hours operation on one set of alkaline batteries
- CSA classified intrinsically safe for Class I, Division I, Groups A, B, C, and D hazardous atmospheres (PENDING)

WARNING: The SC-01 detects toxic gases which can be dangerous or life threatening. When using the SC-01, you must follow the instructions and warnings in this manual to assure proper and safe operation of the unit and to minimize the risk of personal injury.

Specifications

Table 1: 01 Series Specifications

Available Target Gas/ Detection Range/ Display Increment	<ul style="list-style-type: none"> • Ammonia (NH₃): 0 - 75.0 ppm, 0.5 ppm increments • Carbon Monoxide (CO): 0 - 75.0 ppm, 0.5 ppm increments • Chlorine (Cl₂): 0 - 3.00 ppm, 0.02 ppm increments • Hydrogen Sulfide (H₂S): 0 - 30.0 ppm, 0.2 ppm increments • Phosphine (PH₃): 0 - 1.00 ppm, 0.01 ppm increments • Sulphur Dioxide (SO₂): 0 - 6.00 ppm, 0.05 ppm increments
Detection Principle	Electrochemical
Sampling Method	Diffusion
Response Time	90% in 60 seconds
Accuracy	± 5% of detection range full scale
Indication	Digital LCD
Safety/Regulatory	 <p>CSA classified, "C/US", as Intrinsically Safe. Exia. Class I, Groups A, B, C, & D. Temperature Code T3.</p>
Power Source	Two AA size Alkaline Batteries Standard, Duracell MN1500 or PC1500
Continuous Operating Hours	At 25 °C: Over 250 Hours, No Alarms or Backlighting
Case	High-impact Plastic, Dust and Weather Proof
Standard Accessories	<ul style="list-style-type: none"> • Alligator Clip • Rubber protective boot
Optional Accessories	<ul style="list-style-type: none"> • Calibration Cup • Calibration Kit • Belt Clip • 10 ft. Extender Cable • Data Logging Kit
Dimensions and Weight	<ul style="list-style-type: none"> • 2.5" W x 5.2" H x 1.2" D (63 mm x 131 mm x 31 mm) • 7.6 ounces (215 g)
Operating Temp. & Humidity	14°F to 104°F (-10°C to +40°C), below 95% RH (non condensing)

Description

This section describes the components of the SC-01. These components include the SC-01's protective rubber boot, case, alligator or belt clip, sensor retainer, sensor, LCD, control buttons, infrared (IR) communications port, printed circuit boards, alarm LEDs, buzzer, vibrator, and batteries.

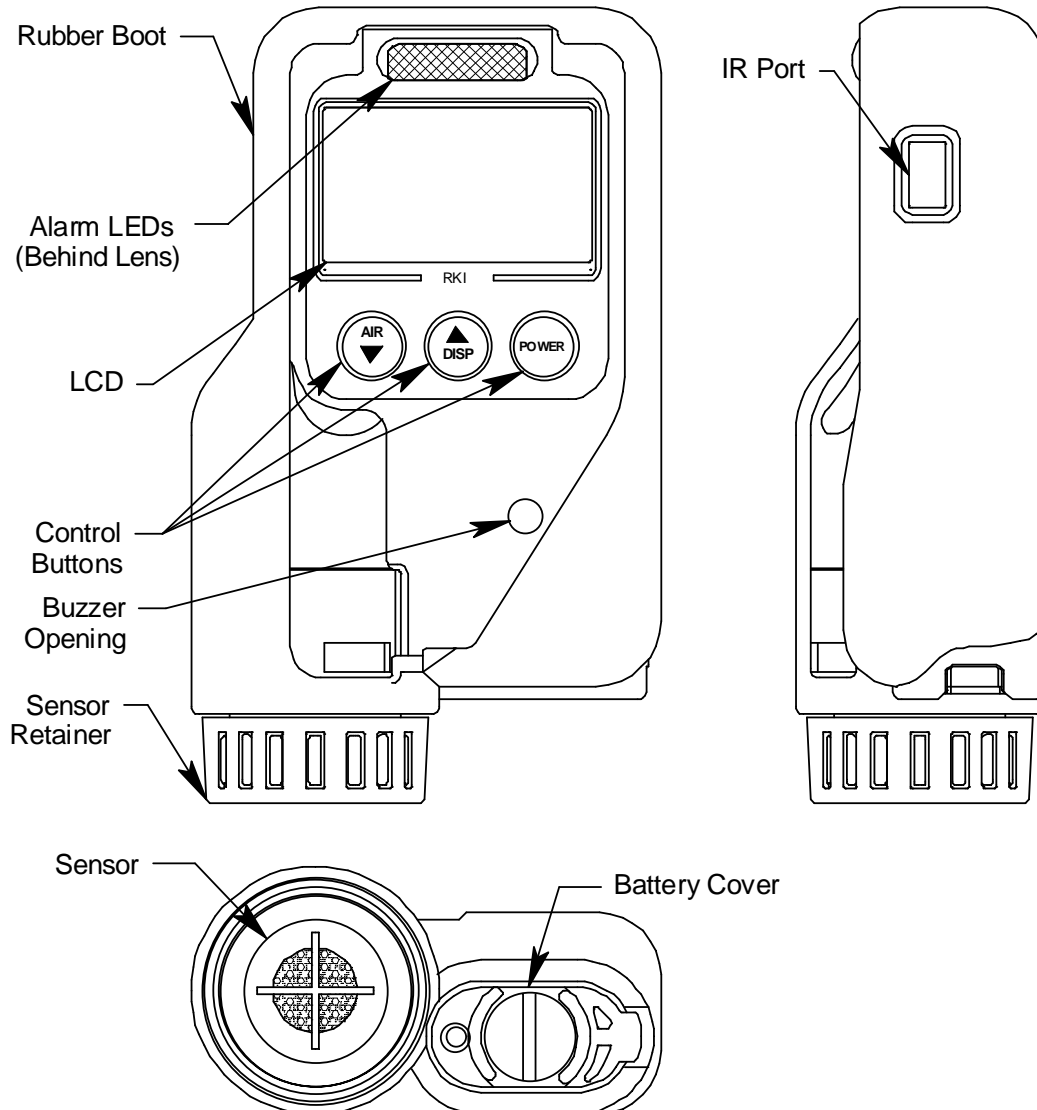

Figure 1: SC-01 Component Location

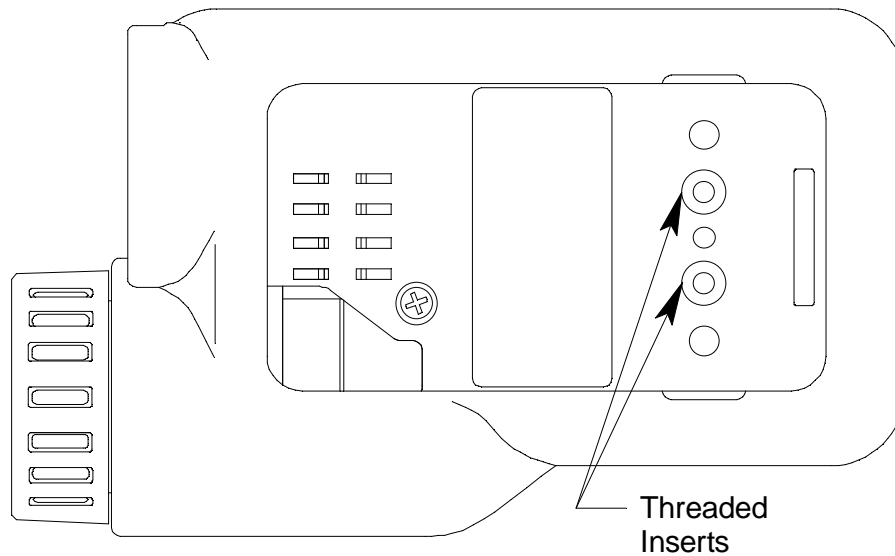

Figure 2: SC-01 Rear View

Protective Rubber Boot

A rubber boot installed over the case helps protect the SC-01. The boot allows viewing of the display and alarm lights and access to the control buttons, battery cover, sensor, and belt clip. The sensor must be removed to remove the protective rubber boot.

Case

The SC-01's sturdy, high-impact plastic case is radio frequency (RF) resistant and is suitable for use in many environmental conditions, indoors and out. It is dust proof and weather resistant.

A clear plastic window through which the LCD can be viewed is located on the front of the case. A frosted plastic lens above the LCD allows viewing of the alarm lights. The three control buttons are below the LCD. The left button is labeled "AIR ▼", the middle button is labeled "▲ DISP" and the right button is labeled "POWER." Below the control buttons on the right side of the front, the buzzer is located inside the case. A hole with a protective membrane allows the buzzer sound out of the case.

The sensor protrudes out the bottom left of the case. The battery cover is located to the right of the sensor and allows access to the batteries. The IR port is located on the right side of the case.

There are two threaded holes on the back of the case. These are used to mount the alligator clip or the optional belt clip.

Alligator and Belt Clips

The SC-01 is available with two types of clips, the standard alligator clip and the optional belt clip. Both are illustrated in Figure 3 below.

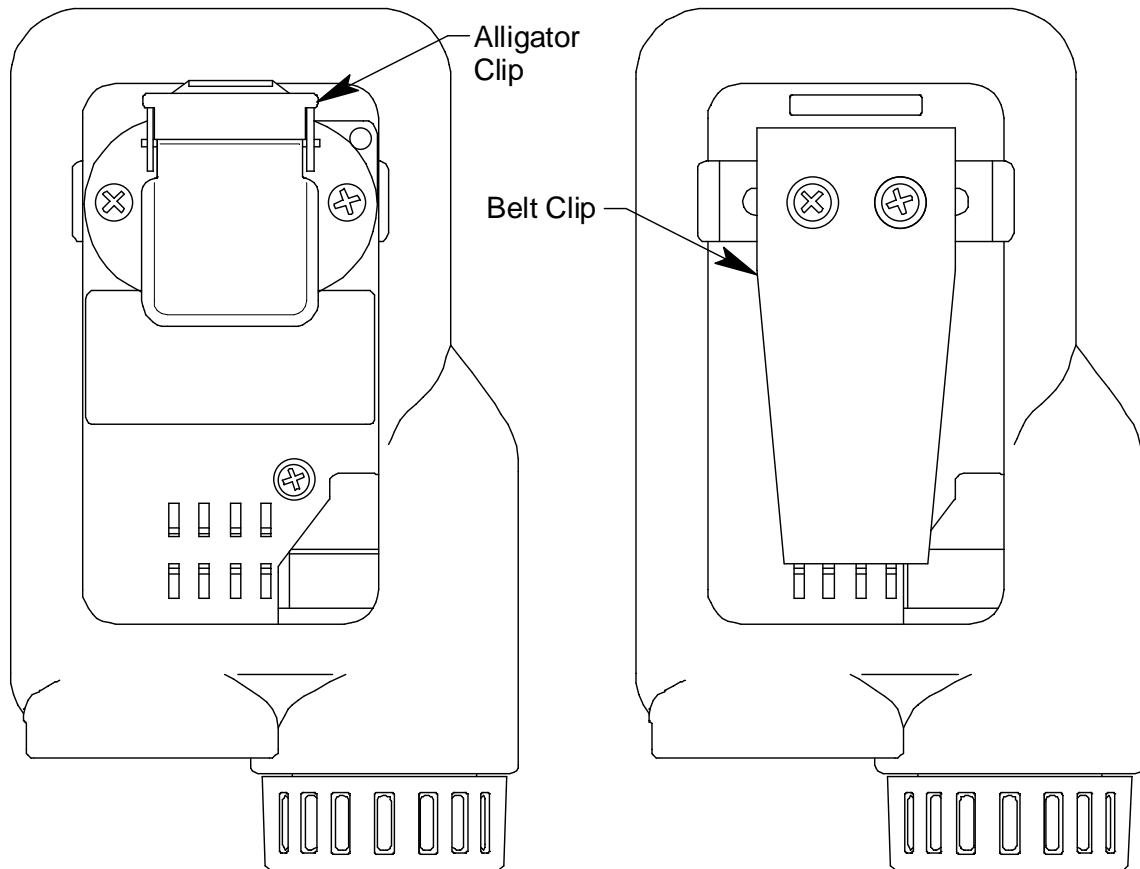

Figure 3: Alligator & Belt Clips

The alligator clip can be used to attach the SC-01 to clothing or a belt. Teeth in the alligator clip's jaws prevent the unit from slipping off. The belt clip is used to easily clip the SC-01 on a belt.

Sensor Retainer

The sensor retainer is a tubular high impact plastic piece that retains the sensor in the sensor socket. A rubber guard on the end of the end of the retainer protects the sensor from impact and an o-ring on the inside and on the outside of the retainer seal the retainer to the sensor and to the SC-01 case. The end of the retainer is open to allow ambient air to reach the sensor.

The sensor retainer slides over the sensor into the case and locks in place with an eighth turn clockwise. Refer to "Replacing the Sensor" on page 37 for instructions to remove and install the sensor retainer.

Sensor

The SC-01 is capable of accepting a variety of toxic gas sensors. The sensor is cylindrically shaped with a multi-pin plug on one end that mates with the sensor socket in the SC-01 and a diffusion port on the other end that allows ambient air to reach the sensor. The diffusion port on the end of the sensor is protected by two plastic ribs in a cross pattern.

The various sensors used in the SC-01 are “smart” sensors. They have imbedded memory that saves several parameters including the target gas, detection range, Warning and Alarm setpoints, the most recent calibration date, and the most recent calibration settings. This allows the SC-01 to have true plug and play capability. If a calibrated sensor of one type is exchanged with a sensor in the SC-01 of another type, the SC-01 will be able to retrieve all the information necessary to monitor for the new target gas from the new sensor without additional user setup. See “Parts List” on page 41 for a list of the available sensors.

LCD

The LCD is visible through the front of the case. When the SC-01 is in Measuring Mode, the target gas concentration, battery condition, and alarm indications are displayed on the LCD. Various other items are displayed when the LCD is in other modes, such as Setup Mode. When either of the three control buttons are pressed, the LCD backlight comes on for 30 seconds.

Control Buttons

Below the LCD are three control buttons: AIR ▼, DISP ▲, and POWER. The functions performed by the control buttons are summarized in the following table:

Table 2: SC-01 Control Buttons

Button	Function
AIR ▼	<ul style="list-style-type: none">• Turns the LCD back light on.• Adjusts LCD readings when a fresh air adjustment is performed.• Enters Setup Mode with the POWER button.• Decreases a parameter’s value or changes a parameter’s setting when a parameter is available for adjustment in an operational mode.

Table 2: SC-01 Control Buttons

Button	Function
▲ DISP	<ul style="list-style-type: none">• Turns the LCD back light on.• Enters and scrolls through Display Mode when the SC-01 is in Measuring Mode• Increases a parameter's value or changes a parameter's setting when a parameter is available for adjustment in an operational mode.
POWER	<ul style="list-style-type: none">• Turns the unit on and off.• Turns the LCD back light on.• Resets the alarm circuit (gas alarms).• Enters Setup Mode with the AIR button.

Printed Circuit Boards

The primary function of the SC-01 printed circuit boards is to amplify the signal sent to them from the sensor, convert the signal to a meaningful measurement of gas concentration, display the gas concentration on the LCD, store peak gas readings, STEL and TWA values, and activate the alarm circuit if an alarm point has been reached. They monitor battery level, battery failure, and sensor failure. They also control the various operating modes of the unit.

NOTE: The printed circuit boards contain no user serviceable parts.

Alarm LEDs

The SC-01 has four red alarm LEDs. They alert you to gas, low battery, and sensor failure alarms. They are located on the front of the SC-01 above the display behind a frosted plastic lens.

Buzzer

A solid-state electronic buzzer is mounted inside the SC-01. An opening in the lower right corner of the case front allows the buzzer's sound to emanate from the case. The buzzer sounds for gas alarms, unit malfunctions, and dead battery alarm. It also serves as an indicator during normal use of the various LCD display options.

Vibrator

A vibrating motor (vibrator) is mounted inside the SC-01. The vibrator vibrates momentarily during the power-up sequence and for gas alarms.

Batteries

Two AA-size alkaline batteries run the SC-01. At 25°C with no alarms, the alkaline batteries last at least 250 hours. The battery icon on the LCD shows remaining battery life.

When the SC-01 detects low battery voltage, a low battery warning is activated. When battery voltage is too low for normal operation, the SC-01 sounds a dead battery alarm.

The alkaline batteries can be replaced by removing the battery door at the bottom of the case. See “Replacing the Batteries” on page 36 for instructions to change the batteries.

WARNING: To prevent ignition of a hazardous atmosphere, batteries must only be changed in an area known to be nonhazardous.

Start Up

This section explains how to start up the SC-01 and to get it ready for operation.

Start-up Procedure

1. Press and briefly hold the POWER button until you hear a beep to turn on the SC-01.

All the alarm LEDs turn on for a few seconds, then the vibrator activates briefly. While this is happening, all elements of the LCD display and the LCD backlight turn on for several seconds.

2. If the CAL. LIMIT menu item in Setup Mode is on, then one of the two following startup sequences takes place. If CAL. LIMIT is turned off, the startup sequence in Step 3 below takes place. See “Updating the Calibration Frequency” on page 33 for a description of the CAL. LIMIT.
 - If calibration is past due, the following screen appears with “CAL.” flashing and the LEDs and buzzer pulsing several times alerting you that the SC-01 is due for calibration. If this screen appears, wait for the buzzer and LED pulsing to stop, then press and release the POWER button to continue in the startup sequence.



The SC-01 will then show the current date, current battery voltage, detection range full scale, and the alarm point settings before proceeding to Measuring Mode and beeping twice.

- If the calibration is up to date, the SC-01 then displays the calibration due date, how many days until the next calibration, current date, current battery voltage, detection range full scale, and the alarm point settings before proceeding to Measuring Mode and beeping twice.
3. If the CAL. LIMIT menu item in Setup Mode is turned off, the SC-01 shows “WARMUP” in the upper left of the LCD for a few seconds, the displays the current date, current battery voltage, detection range full scale, and the alarm point settings before proceeding to Measuring Mode and beeping twice.

CAUTION: *If the instrument gives a low battery warning or dead battery alarm, change the alkaline batteries before using the instrument. See “Alarm Indications” on page 17 for a description of the battery alarm indications.*

4. The SC-01 is now operating in Measuring Mode and the concentration of the target gas is displayed on the LCD. The backlight turns off after 30 seconds.

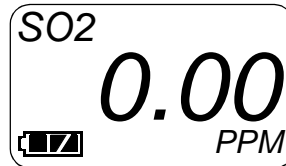

Performing a Fresh Air Adjustment

Before using the SC-01, set the fresh air reading. Performing this adjustment ensures accurate gas readings in the monitoring environment the calibration is current.

1. Find a fresh air environment, an environment of normal oxygen content (20.9%) that is free of toxic or combustible gasses.
2. With the unit on and in Measuring Mode, press and hold the AIR ▼ button. The LCD displays “hold” prompting you to hold the AIR ▼ button



3. After a moment, the LCD will indicate “Adj.”. Continue to hold the AIR ▼ button.



4. Release the AIR ▼ button when the LCD displays “RELEASE” in the upper left corner.



5. The unit will take a few seconds to set the reading to 0 ppm, then indicate “FINISH” in the upper left corner of the LCD and return to Measuring Mode.

Turning Off the SC-01

1. Press and hold the POWER button for about five seconds to turn off the unit. The buzzer will sound while the POWER button is being pressed before the unit turns off.
2. Release the button when the LCD indicates “GOOD-BYE” in the upper right corner.

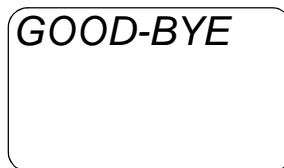

Operation in Measuring Mode

This section covers the operation of the SC-01 in Measuring Mode. It explains Normal Operation, Display Mode, and alarm indications.

Normal Operation

When the SC-01 comes out of its startup sequence, see “Start Up” on page 13, it is in normal operation if no alarm indications are taking place. It is advisable to perform a fresh air adjustment when the SC-01 comes out of its startup sequence as described in “Start Up”.

In the Normal Operation screen of Measuring Mode, the battery level, target gas, and target gas concentration are displayed on the LCD. The battery icon has three bars visible when the batteries have a full charge. As the battery charge decreases, the bars will gradually disappear, one by one from left to right.

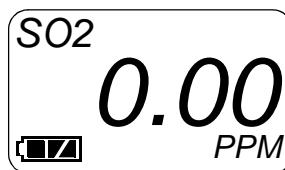

Figure 4: LCD in Measuring Mode

Display Mode

You can access Display Mode when in Measuring Mode by using the ▲ DISP button. In Display Mode you can view the detection range full scale, peak reading, the STEL value, and the TWA value, the date and time, and the amount of datalogging time remaining. STEL is an acronym for short-term exposure limit, and it is the average reading of the target gas during the last 15 minutes. TWA is an acronym for time-weighted average, and it is the average reading for the target gas during the last eight (8) hours. If eight (8) hours has not elapsed since the unit was turned on, the TWA is still calculated over eight hours, with the missing time assigned a zero (0) value for the readings. Similarly, if the unit has not been on for 15 minutes, the missing time is assigned a 0 value and the STEL is calculated over 15 minutes. The peak reading, STEL value, and TWA value are cleared when the unit is turned off.

To view the various items in Display Mode, do the following:

1. Make sure the SC-01 is in Measuring Mode. The SC-01 must be in Measuring Mode for you to access Display Mode.

2. Press and release the ▲ DISP button to enter Display Mode. The LCD backlight will activate and the LCD will display the detection range full scale value.
3. Press and release the ▲ DISP button again to proceed to the PEAK Screen. The LCD displays the peak gas reading since the SC-01 was turned on.
4. Press and release the ▲ DISP button again to proceed to the STEL Screen. The LCD displays the STEL value.
5. Press and release the ▲ DISP button again to proceed to the TWA Screen. The LCD displays the TWA value.
6. Press and release the ▲ DISP button again to proceed to the Date/Time Screen. The LCD displays the current date and time.
7. Press and release the ▲ DISP button again to proceed to the Log Remaining screen. The LDC displays how much datalogging time remains.
8. Press and release the ▲ DISP button once again to return to the unit to Measuring Mode.

NOTE: If you do not press a button for 20 seconds while in Display Mode, the SC-01 will return to Measuring Mode automatically and the backlight will turn off 30 seconds since the last button was pressed.

Alarms

This section covers alarm indications. It also tells you how to reset the SC-01 after an alarm has occurred and how to respond to an alarm condition. See Table 6 on page 32 for the standard alarm point settings.

Alarm Indications

The SC-01 will sound an alarm, flash its alarm lights, and vibrate when the target gas concentration rises above the Warning level. The SC-01 also sounds an alarm, flashes its alarm lights, and vibrates when the Alarm level is reached. In addition, the SC-01 has a low battery warning, a dead battery alarm, an over range alarm, a sensor failure alarm, and a system failure alarm. See Table 3 below for a description of each alarm indication.

Table 3: Alarm Types and Indications

Alarm Type	LCD Indications	Other Indications
<p>Warning Concentration of gas rises above the Warning level.</p>	<ul style="list-style-type: none"> • Gas reading flashes. • Back light turns on. 	<ul style="list-style-type: none"> • Pulsing tone alternates with alarm LEDs flashing once per second. • Unit vibrates once per second.
<p>Alarm Concentration of gas rises above the Alarm level.</p>	<ul style="list-style-type: none"> • Gas reading flashes. • Back light turns on. 	<ul style="list-style-type: none"> • Pulsing tone alternates with alarm LEDs flashing twice per second. • Unit vibrates twice per second.
<p>TWA or STEL Concentration of target gas rises above the TWA or STEL alarm point.</p>	<ul style="list-style-type: none"> • Back light turns on. • Gas reading flashes • TWA or STEL replaces the gas name in the upper left of the LCD. 	<ul style="list-style-type: none"> • Pulsing tone alternates with alarm LEDs flashing once per second. • Unit vibrates once per second
<p>Over Range Concentration of gas rises above the full scale of the SC-01. (Or there could be a problem with the unit.)</p>	<ul style="list-style-type: none"> • Gas reading replaced by blinking brackets. □□□□ • Back light turns on. • Gas name in upper right of display replaced by OVER 	<ul style="list-style-type: none"> • Pulsing tone alternates with alarm LEDs flashing twice per second. • Unit vibrates twice per second.
<p>Low Battery Warning</p>	<p>Last remaining bar on the right in battery icon flashes.</p>	<p>None</p>
<p>Dead Battery Alarm</p>	<ul style="list-style-type: none"> • Gas name and reading replaced by BATTERY FAIL. • Battery icon flashes. 	<p>Quick pulsing tone and LED flashing for a few seconds alternates with the unit vibrating for one second.</p>

Table 3: Alarm Types and Indications

Alarm Type	LCD Indications	Other Indications
Sensor Failure	Gas name and reading replaced by SENSOR FAIL.	Quick pulsing tone and LED flashing for a few seconds alternates with the unit vibrating for one second.
System Failure	Gas name and reading replaced by CIRCUIT FAIL.	
Clock Failure	Gas name and reading replaced by CLOCK FAIL	

Resetting Gas Alarms

To reset a gas alarm, press and release the POWER button after the gas reading falls below the Warning level. If a TWA or STEL alarm has been activated, it cannot be reset unless you turn off the unit.

NOTE: Even though the gas concentration may have returned to normal or may have fallen below the low alarm point, the alarm indications will continue until you have reset the alarm using the POWER button.

Responding to Alarms

This section describes response to gas, over range, battery, sensor failure, and system failure alarms.

Responding to Gas Alarms

1. Follow your established procedure for an increasing gas condition.
2. Reset the alarm by pressing and releasing the POWER button after the alarm condition has been cleared.

Responding to an Over Range Alarm

WARNING: *An over range condition may indicate an extreme toxic gas concentration. Confirm the gas concentration with a different SC-01 or with another gas detecting device.*

1. Follow your established procedure for an increasing gas condition.
2. Reset the alarm by pressing and releasing the POWER button after the alarm condition has cleared.

3. Calibrate the SC-01 as described in “Maintenance” on page 34.
4. If the over range condition continues, you may need to replace the sensor.
5. If the over range condition continues after you have replaced the sensor, contact RKI Instruments, Inc. for further instructions.

Responding to Battery Alarms

WARNING: *The SC-01 is not operational as a gas monitoring device during a dead battery alarm. Take the SC-01 to a non-hazardous area and change the alkaline batteries as described in “Replacing the Batteries” on page 36.*

The SC-01 is fully functional in a low battery warning condition. However, only about eight hours of operation may remain depending on certain conditions such as alarm occurrences and how often the backlight comes on.

NOTE: Alarms and the back light feature consume battery power and reduce the amount of operating time remaining.

When a low battery warning occurs, change the batteries as soon as possible. See “Replacing the Batteries” on page 36” for instructions to change the batteries.

Responding to a Sensor Failure Alarm

1. Try to calibrate the SC-01 as described in “Performing a Fresh Air Adjustment” on page 26 and “Performing a Span Adjustment” on page 27 before replacing the sensor.
2. If the sensor failure continues, replace the sensor as described in “Replacing the Sensor” on page 37.
3. If the sensor failure condition continues after you have replaced the sensor, contact RKI Instruments, Inc. for further instructions.

Responding to a Circuit Failure Alarm

1. If a circuit failure occurs, try turning the unit off then on again.
2. If the unit remains in circuit failure, contact RKI Instruments, Inc. for further instructions.

Responding to a Clock Failure Alarm

1. If a clock failure occurs, try turning the unit off then on again.
2. If the unit remains in clock failure, contact RKI Instruments, Inc. for further instructions.

Using the SC-01 With the Optional Extender Cable

The SC-01 can be used with an optional extender cable in applications where it is necessary that the sensor be remote from the instrument. The sensor is removed from the instrument and the cable is connected to the instrument on one end and to the sensor on the other.

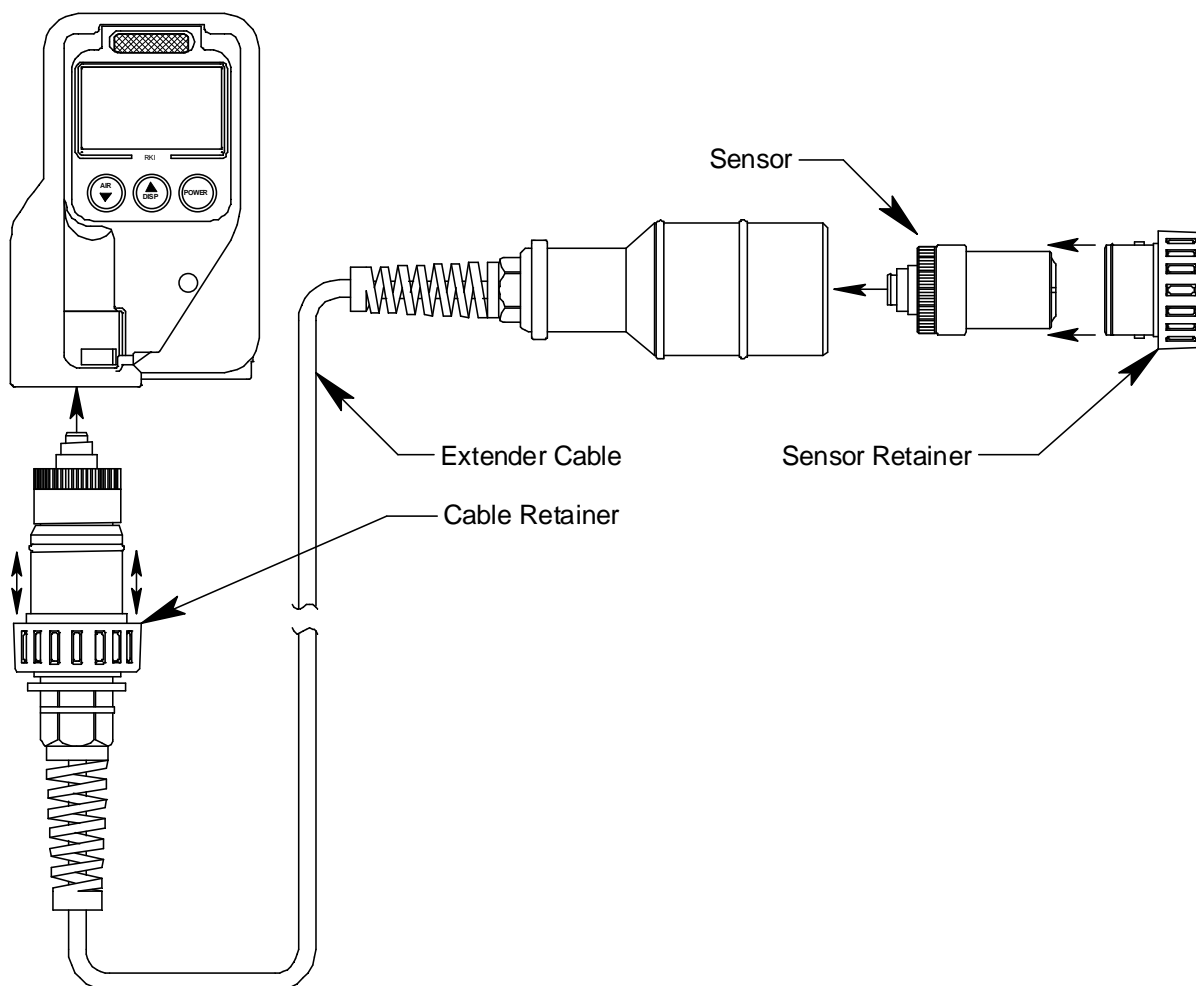

Figure 5: The SC-01 With an Extender Cable

Do the following to install the extender cable.

1. Verify that the SC-01 is off.
2. Grasp the rubber guard on the sensor retainer firmly and turn it counterclockwise about 1/8 turn. A yellow line on the rubber guard will indicate the proper amount of rotation by lining up with a yellow line on the instrument body that indicates "UNLOCK".
3. Pull the sensor retainer away from the SC-01 and it will slide out of the SC-01.

4. If the sensor retainer slides out with the sensor, pull the sensor out of the bottom of the sensor retainer.
If the sensor retainer slides out without the sensor, pull the sensor out of the SC-01.
5. Insert the connector (plug) end of the sensor into the sensor end of the extender cable and gently push it in until it bottoms out with the sensor plug on the end of the sensor contacting the sensor socket at the bottom of the cable's sensor opening. ***Do not try to push the sensor any farther into the extender cable sensor opening once it bottoms out.***
6. With the sensor plug gently touching sensor socket, turn the sensor clockwise or counterclockwise while pushing the sensor very lightly until you feel it drop into place as the sensor plug aligns with the sensor socket and partially engages it. With the sensor plug and sensor socket partially engaged, the sensor will no longer rotate freely.

CAUTION: *Do not force the sensor into the sensor socket. Forcing a sensor into the sensor socket may damage the sensor or the socket.*

7. With the sensor plug and sensor socket partially engaged, push the sensor into the extender cable so that the sensor plug fully engages the sensor socket. This will push the sensor in about 1/16" farther than the partially engaged position.
8. Align the tab on the sensor retainer that is aligned with the yellow line on the sensor retainer's rubber guard with the notch in the extender cable's sensor opening that is lined up with the UNLOCK yellow line and slide the sensor retainer over the sensor pushing it into the sensor opening over the sensor.
9. Make sure the tab on the sensor retainer below the yellow line engages the mating notch in the extender cable's sensor opening, then push the sensor retainer as far as it will go and turn it 1/8 turn clockwise until it locks in place.
10. On the plug end of the extender cable, slide the captive cable retainer as far away as possible from the end of the cable. The cable retainer must stay in this position until Step 14 below.
11. Insert the plug end of the extender cable into the sensor opening in the SC-01 case and gently push it in until it bottoms out with the plug on the end of the extender cable contacting the sensor socket at the bottom of the sensor opening. ***Do not try to push the extender cable any farther into the sensor opening once it bottoms out.***

12. With the extender cable plug gently touching sensor socket, turn the extender cable plug clockwise or counterclockwise while pushing it very lightly until you feel it drop into place as the plug aligns with the sensor socket and partially engages it. With the extender cable plug and sensor socket partially engaged, the plug will no longer rotate freely.

CAUTION: *Do not force the extender cable plug into sensor socket. Forcing a sensor into the sensor socket may damage the sensor or the socket.*

13. With the extender cable plug and sensor socket partially engaged, push the plug into the SC-01 so that the plug fully engages the sensor socket. This will push the plug in about 1/16" farther than the partially engaged position.
14. Align the yellow line on the cable retainer's rubber guard with the "UNLOCK" line on the case and slide the cable retainer into the sensor opening over the extender cable plug.
15. Make sure the tab on the cable retainer below the yellow line engages the mating notch in the case's sensor opening, then push the cable retainer as far as it will go and turn it 1/8 turn clockwise until it locks in place.
16. The SC-01 is now ready for use with the extender cable.

Data Logging

The SC-01 features the ability to log data to its internal memory and download it to a computer via the infrared communications port on the upper right side. It logs gas readings during normal operation, alarm data, and calibration data.

To utilize the SC-01's downloading capability, you will need the SC-01 Data Logger Management Program and a computer with an infrared port, a USB port, or a serial port that runs one of the following operating systems: Windows 98, Windows 2000, or Windows XP. If your computer has an infrared port, then no additional accessories are needed to download data from the SC-01. If your computer does not have an infrared port but does have a USB or serial port, a USB/IrDA adapter cable or a serial/IrDA adapter cable can be used to download data from the SC-01 using a USB or serial port. The downloading software is available from RKI Instruments, Inc. The adapter cables are available from RKI or may be purchased at a computer or electronics supply store. Data logging kits that include the software and either a serial/IrDA or USB/IrDA cable are also available from RKI. See the "Parts List" on page 41 for a list of data logging accessories.

Table 4 below lists the SC-01's data logging capacity for each interval trend time setting.

Table 4: SC-01 Data Logging Capacity

Interval Trend Time	Data Logging Hours¹
10 seconds	150 hours
30 seconds	450 hours
60 seconds	900 hours
180 seconds (3 minutes)	2,700 hours
300 seconds (5 minutes)	4,500 hours
600 seconds (10 minutes)	9,000 hours
¹ Logging hours assume that no alarms or other events occur.	

The interval trend time cannot be set using the SC-01's user menus. It can only be set using the Data Logger Management Program. For a complete description of the Data Logger Management Program and procedures for downloading data to a computer, see the SC-01 Data Logger Management Program Operator's Manual.

Setup Mode

This section describes the SC-01 in Setup Mode. In Setup Mode, you can move through a menu of screens to do the following:

- Set the date and time
- Perform a fresh air adjustment (part of a calibration)
- Perform a span adjustment (part of a calibration)
- Update the alarm point settings
- Update the calibration frequency

Using Setup Mode

WARNING: *The SC-01 is not in operation as a gas detector while in Setup Mode. Although it will respond to gas in parts of AIR CAL and SPAN CAL, there are no alarm indications.*

1. Take the SC-01 to a non-hazardous area and turn it off if it is on.
2. Press and hold the AIR ▼, then press and hold the POWER button. When you hear a beep release the buttons. After a few seconds, the first menu item in Setup Mode displays, the DATE Screen.



3. Use the AIR ▼ button to move forward through Setup Mode and the ▲ DISP button to move back through Setup Mode.
4. When you arrive at the item you wish to enter, press and release the POWER button to enter that item.

The Setup Mode menu items are described below in the order in which they appear while moving forward through Setup Mode.

Setting the Date and Time

Entering the DATE menu item allows you to set the date and time.

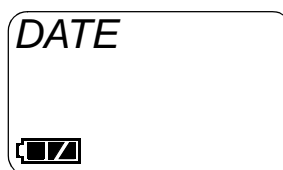

1. When the DATE Screen is displayed, press and release the POWER button. A screen appears with the year flashing in the upper left, the date in the middle, and the time in the lower right.



2. Use the AIR ▼ or the ▲ DISP button to display the desired year.
3. Press and release the POWER button to save the setting. The month setting flashes.
4. Repeat steps 2 and 3 to enter the month, day, hour and minute setting. When you save the minute setting, you return to the DATE Screen.

Performing a Fresh Air Adjustment

Entering the AIR CAL menu item allows you to perform a fresh air adjustment.

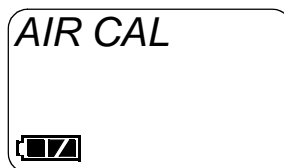

Perform a fresh air adjustment when you are performing a calibration before proceeding to the next menu item, SPAN CAL, to perform a span adjustment.

WARNING: Calibrate the SC-01 in a non-hazardous environment.

1. Find a fresh air environment, an environment of normal oxygen content (20.9%) that is free of toxic or combustible gasses.
2. When the AIR CAL screen is displayed, press and release the POWER button. A screen appears that displays the current gas reading and prompts you to press the AIR ▼ button with a flashing "PUSH AIR" message at the top of the screen.



3. Press and hold the AIR ▼ button. The LCD displays “hold” prompting you to hold the AIR ▼ button.



4. After a moment, the LCD will indicate “Adj.”. Continue to hold the AIR ▼ button.



5. Release the AIR ▼ button when the LCD displays “RELEASE” in the upper left corner.



6. The unit will take a few seconds to set the reading to 0 ppm, then indicate “FINISH” in the upper left corner of the LCD and return to the AIR CAL Screen.

Performing a Span Adjustment

Entering the SPAN CAL menu item allows you to perform a span adjustment.



Perform a span adjustment as part of a calibration after performing a fresh air adjustment. Performing a span adjustment requires the use of a calibration kit. The procedure below describes a span adjustment using a calibration kit that includes a calibration gas cylinder, a 0.5 LPLM (liters per minute) or 0.25 LPM fixed flow regulator with an on/off knob, one of three different calibration cups, and non-absorbent sample tubing. The required calibration cup and calibration flow rate will depend on the type of SC-01. The direction of flow through the cup may also be specified depending on the cup. See Table 5 below for the calibration cup, calibration flow rate and required regulator, and whether the calibration cup flow direction is specified for the various versions of the SC-01. See “Parts List” on page 41 for available calibration kits and calibration kit spare parts.

Table 5: Required Calibration Cups & Calibration Flow rates

Target Gas	Required Calibration Cup	Required Regulator, Flowrate	Flow Direction Specified on Calibration Cup
Ammonia (NH ₃)	81-1139RK-NH3	81-1051RK-25, 0.25 LPM	No
Carbon Dioxide (CO)	81-1139RK	81-1051RK, 0.5 LPM	Yes
Chlorine (CL ₂)	81-1139RK-CL2	81-1051RK, 0.5 LPM	No
Hydrogen Sulfide (H ₂ S)	81-1139RK	81-1051RK, 0.5 LPM	Yes
Phosphine (PH ₃)	81-1139RK	81-1051RK, 0.5 LPM	Yes
Sulphur Dioxide (SO ₂)	81-1139RK	81-1051RK, 0.5 LPM	Yes

WARNING: Calibrate the SC-01 in a non-hazardous environment.

1. Before performing a span adjustment, perform a fresh air adjustment as described above in “Performing a Fresh Air Adjustment”.
2. Use the sample tubing to connect the calibration cup to the regulator.
The 81-1139RK calibration cup (used for all gasses except Cl₂ and NH₃) has a label on it that indicates the required flow direction through the cup. If the 81-1139RK calibration cup is used, make sure to connect the sample tubing to the appropriate fitting so that the calibration gas flows through the calibration cup in the direction indicated on the label.

WARNING: If the 81-1139RK calibration cup is used and the sample tubing is not connected to the correct fitting on the calibration cup, the calibration will not be accurate.

3. Confirm that the regulator on/off knob is turned all the way clockwise (closed) and screw the calibration gas cylinder onto the regulator. Be sure to use the regulator that generates the required flowrate for your target gas specified in Table 5 above.

WARNING: If the wrong flowrate is used to calibrate your SC-01, the calibration will not be accurate.

4. Push the calibration cup into the sensor retainer over the sensor face.
5. At the SPAN CAL screen, press and release the POWER button. A screen appears that displays the calibration gas concentration that the SC-01 expects you to use.



If the displayed concentration matches the calibration cylinder concentration, continue with the next step.

If the displayed concentration does not match the calibration cylinder concentration, do the following:

- Simultaneously press and release the AIR ▼ and ▲ DISP buttons. The displayed gas concentration will begin to flash.
 - Use the AIR ▼ and ▲ DISP buttons to adjust the displayed gas concentration to match the calibration cylinder concentration
 - Press and release the POWER button to accept the displayed calibration gas concentration. The unit will return to the SPAN VALUE screen.
6. Press and release the POWER button. The current gas reading will be displayed and "SPAN CAL" will begin to flash.

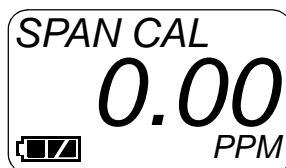

7. Turn the regulator on/off knob counterclockwise to open it. Calibration gas will begin to flow.
8. Allow the gas to flow for two minutes.
9. Press and release the POWER button.
10. The SC-01 will attempt to make a span adjustment.

11. If the span adjustment is successful, the LCD will show the following screen before returning to the SPAN CAL screen.

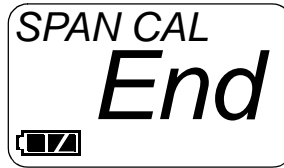

12. If the span adjustment fails, the LCD will show the following screen, flash the alarm LEDs, and pulse the buzzer and vibrator.



When this screen appears, press and release the POWER button. The LCD will show the following screen before returning to the SPAN CAL screen.

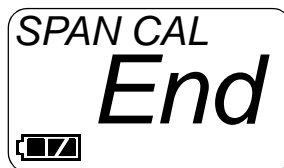

13. Turn the regulator on/off knob clockwise to close it.
14. Remove the calibration cup from the sensor retainer.
15. Remove the regulator from the calibration gas cylinder.
16. Leave the regulator connected to the calibration cup for convenience.
17. Store the components of the calibration kit in a safe and convenient place.

Updating the Alarm Point Settings

Entering the ALARM-P menu item allows you to update the SC-01's alarm point settings.

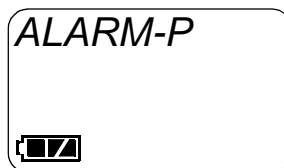

NOTE: The sensor has the standard alarm points saved in it's memory. Changing the alarm points in this menu item does not affect the alarm points that are saved in the sensor. If the sensor is moved to another SC-01, the standard alarm points will be loaded.

1. When the ALARM-P Screen is displayed, press and release the POWER button. The WARNING Screen appears displaying the Warning setpoint. The setpoint is flashing.

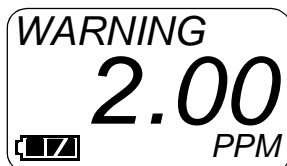

2. Use the AIR ▼ and ▲ DISP buttons to adjust the Warning setpoint to the desired value. To turn the Warn gas alarm off, adjust the alarm point down to towards zero and continue to adjust it down with the AIR ▼ button until "OFF" is displayed.
3. Press and release the POWER button to accept the displayed Warning setpoint. The unit will proceed to the ALARM Screen. The Alarm setpoint is flashing.

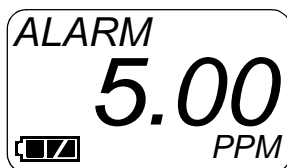

4. Use the AIR ▼ and ▲ DISP buttons to adjust the Alarm setpoint to the desired value. To turn the Alarm gas alarm off, adjust the alarm point down to towards zero and continue to adjust it down with the AIR ▼ button until "OFF" is displayed.
5. Press and release the POWER button to accept the displayed Alarm setpoint. The unit will proceed to the STEL Screen. The STEL setpoint is flashing.

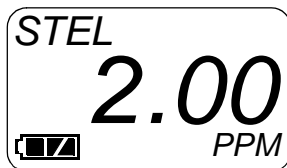

6. Use the AIR ▼ and ▲ DISP buttons to adjust the STEL setpoint to the desired value. To turn the STEL alarm off, adjust the alarm point down to towards zero and continue to adjust it down with the AIR ▼ button until "OFF" is displayed.

- Press and release the POWER button to accept the displayed STEL setpoint. The unit will proceed to the TWA Screen. The TWA setpoint is flashing.

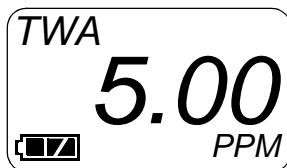

- Use the AIR ▼ and ▲ DISP buttons to adjust the TWA setpoint to the desired value. To turn the TWA alarm off, adjust the alarm point down to towards zero and continue to adjust it down with the AIR ▼ button until "OFF" is displayed.
- Press and release the POWER button to accept the displayed TWA setpoint. The following LCD will show the following screen before returning to the ALARM-P screen.



The standard alarm point settings for the various models of the SC-01 are listed below in Table 6.

Table 6: Standard Alarm Point Settings

Target Gas	Warning	Alarm	TWA	STEL
Ammonia (NH ₃)	25.0 ppm	35.0 ppm	25.0 ppm	35.0 ppm
Chlorine (CL ₂)	0.50 ppm	1.00 ppm	0.50 ppm	1.00 ppm
Carbon Monoxide (CO)	25.0 ppm	50.0 ppm	25.0 ppm	OFF
Hydrogen Sulfide (H ₂ S)	10.0 ppm	20.0 ppm	10.0 ppm	15.0 ppm
Phosphine (PH ₃)	0.30 ppm	0.60 ppm	0.30 ppm	1.00 ppm
Sulphur Dioxide (SO ₂)	2.00 ppm	5.00 ppm	2.00 ppm	5.00 ppm

Updating the Calibration Frequency

Entering the CAL. LIMIT menu item allows you to change the calibration frequency.

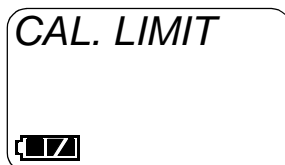

The calibration frequency defines how often a calibration is required. It is set in days. For example, if the calibration frequency is set to 90 days, calibration will be due 90 days after the last successful calibration.

1. When the CAL. LIMIT Screen is displayed, press and release the POWER button. The calibration frequency value appears and is flashing.

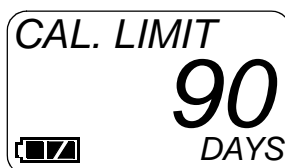

2. Use the AIR ▼ and ▲ DISP buttons to adjust the calibration frequency to the desired number of days. The calibration frequency is adjustable from 1 day to 365 days. To turn the calibration frequency feature off, adjust the frequency down to one day and continue to adjust it down with the AIR ▼ button until "OFF" is displayed.
3. Press and release the POWER button to accept the displayed number of days. The unit will display the following screen before returning to the CAL. LIMIT screen.



Entering Measuring Mode

The last screen in the Setup Mode menu is the START Screen.

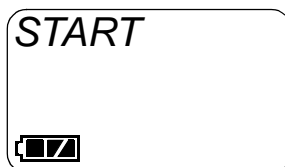

When the START Screen is displayed, press and release the POWER button to exit Setup Mode and begin the SC-01's startup sequence in Measuring Mode.

Maintenance

This section discusses calibration of the SC-01 and describes troubleshooting procedures for the SC-01. It also describes how to change the SC-01's batteries as well as how to replace the sensor.

WARNING: RKI Instruments, Inc. recommends that service, calibration, and repair of RKI instruments be performed by personnel properly trained for this work.

NOTE: Replacing sensors and other parts with original equipment does not affect the intrinsic safety of the instrument.

Calibration

The optimum frequency of calibration depends heavily on how the SC-01 is used. For example, instruments used daily may need to be calibrated weekly or monthly, while instruments that are used only a few times a year may need to be calibrated before each use. Typical calibration frequencies range from monthly to quarterly. For most applications, RKI Instruments, Inc. recommends a quarterly calibration schedule (every three months). Make sure to develop a calibration schedule tailored to your application.

Calibrate the SC-01 while in Setup Mode. To perform a complete calibration, enter Setup Mode as described in "Using Setup Mode" on page 25, then perform both a fresh air adjustment and a span adjustment while in Setup Mode. See "Performing a Fresh Air Adjustment" on page 26 and "Performing a Span Adjustment" on page 27 for instructions.

Troubleshooting

The troubleshooting table describes error messages, symptoms, probable causes, and recommended actions for problems you may encounter with the SC-01.

Table 7: Troubleshooting the 01 Series

Symptoms	Probable Causes	Recommended Action
<ul style="list-style-type: none"> The LCD is blank. 	<ul style="list-style-type: none"> The unit may have been turned off. The alkaline batteries may need to be replaced. 	<ol style="list-style-type: none"> To turn on the unit, press and briefly hold the POWER button until you hear a beep. If the unit does not turn on, replace the alkaline batteries. If the difficulties continue, contact RKI Instruments, Inc. for further instruction.
<ul style="list-style-type: none"> The LCD shows abnormally high readings but other gas detection instruments do not. 	<ul style="list-style-type: none"> The unit may need to be calibrated. The sensor may need replacement. 	<ol style="list-style-type: none"> Calibrate the unit. Replace the sensor and calibrate the unit. If the difficulties continue, contact RKI Instruments for further instruction.
<ul style="list-style-type: none"> “SPAN CAL FAIL” displays during span adjustment. 	<ul style="list-style-type: none"> The calibration value may not match the cylinder gas concentration. The calibration tubing is not connected to the correct calibration cup port. The sample gas is not reaching the sensor because of a bad tubing connection. The calibration cylinder may be out of gas or is outdated. The sensor may need replacement. 	<ol style="list-style-type: none"> Check the calibration tubing for leaks or for any bad connections. Confirm that the calibration tubing is connected to the correct calibration cup port. Make sure the SC-01 calibration gas value has been properly set up to match the calibration cylinder concentration. Verify that the calibration cylinder contains an adequate supply of fresh test sample. If the fail condition continues, replace the sensor. If the difficulties continue, contact RKI Instruments, Inc. for further instruction.
<ul style="list-style-type: none"> “CIRCUIT FAIL” displays on the LCD. 	<ul style="list-style-type: none"> A circuit failure has occurred. 	<ol style="list-style-type: none"> Turn off the unit and turn it on again. If difficulties continue, contact RKI Instruments, Inc.

Replacing the Batteries

WARNING: To prevent ignition of a hazardous atmosphere, batteries must only be changed in an area known to be nonhazardous.

Replace the batteries when the battery icon indicates that the unit is in low battery warning. When in low battery warning, only the right most battery level indication bar is displayed in the battery icon on the LCD, and the icon will be flashing.



NOTE: Use AA size alkaline batteries MN1500 or PC1500 manufactured by Duracell to maintain the CSA classification of the SC-01.

To Replace the Batteries

1. Verify that the SC-01 is off.
2. Rotate the captive quarter turn fastener in the battery cover a quarter turn counterclockwise and lift up the end of the battery cover to remove it. A coin may be used to rotate the fastener.

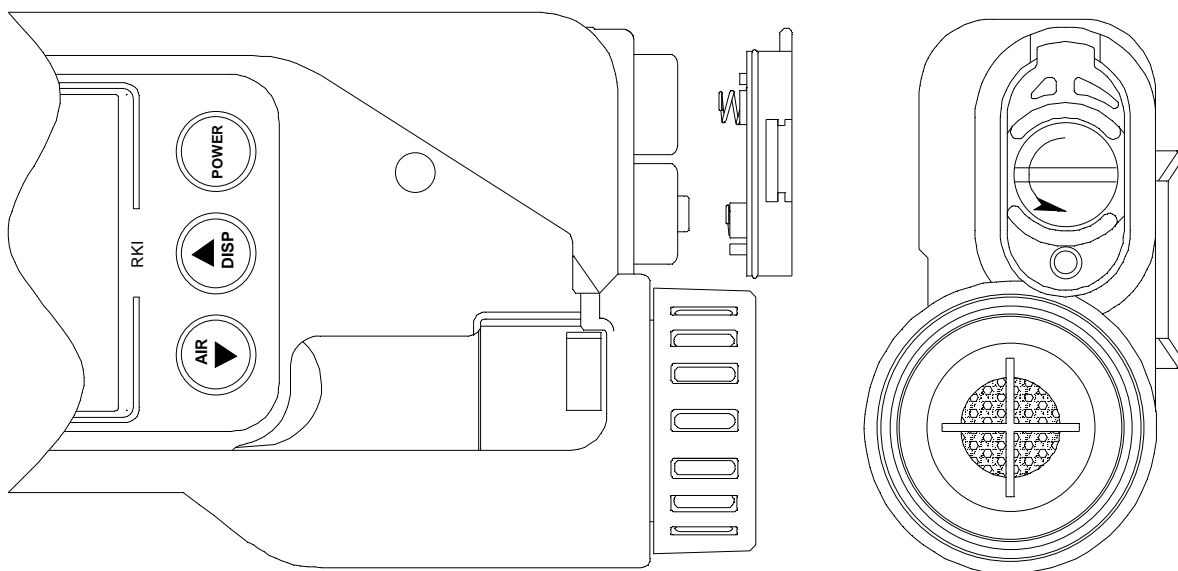

Figure 6: Removing the Battery Compartment Door

3. Carefully remove the old alkaline batteries.
4. Carefully install the new AA alkaline batteries. Follow the battery diagram inside the battery compartment.

5. Reinstall the battery cover.

NOTE: If the unit has been without batteries or if the old batteries have been dead for an extended period, allow 5 minutes after the new batteries have been installed for the sensor to stabilize.

Replacing the Sensor

WARNING: *Replace the sensor in a non-hazardous environment.*

Since the SC-01 sensor is capable of saving calibration information in its memory, replacement sensors are shipped from the factory calibrated. So when the replacement sensor is installed, it will not be necessary to calibrate the sensor unless it has been stored so long that the installation date is past the calibration due date defined by the SC-01. If the SC-01 has the CAL. LIMIT item in Setup Mode turned off so that the SC-01 will not alert you if calibration is due, then RKI Instruments, Inc. recommends that you calibrate the sensor if it is installed more than 3 months after the ship date from the factory.

1. Verify that the SC-01 is off.
2. Grasp the rubber guard on the sensor retainer firmly and turn it counterclockwise about 1/8 turn. A yellow line on the rubber guard will indicate the proper amount of rotation by lining up with a yellow line on the instrument body that indicates "UNLOCK".
3. Pull the sensor retainer away from the SC-01 and it will slide out of the SC-01.
4. If the sensor retainer slides out with the sensor, pull the old sensor out of the bottom of the sensor retainer.

If the sensor retainer slides out without the sensor, pull the old sensor out of the SC-01.
5. Insert the connector (plug) end of the replacement sensor into the sensor opening in the SC-01 case and gently push it in until it bottoms out with the sensor plug on the end of the sensor contacting the sensor socket at the bottom of the sensor opening. ***Do not try to push the sensor any farther into the sensor opening once it bottoms out.***

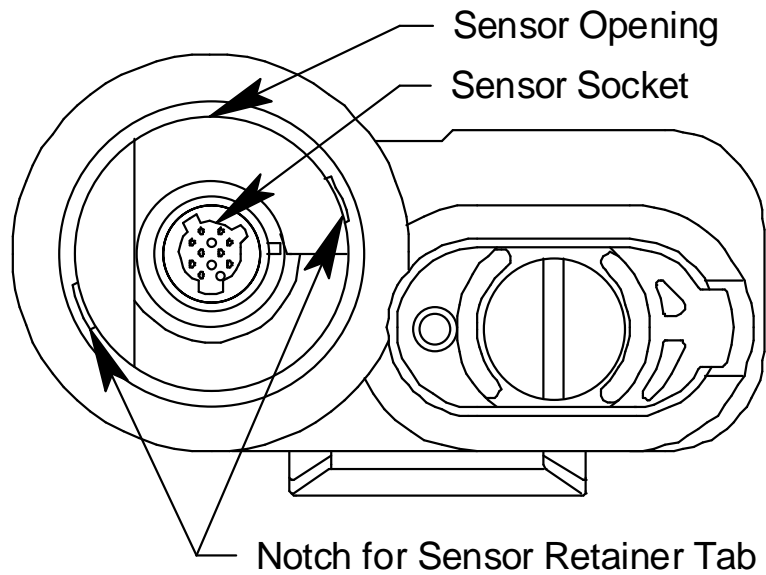

Figure 7: Sensor Opening & Sensor Socket in SC-01

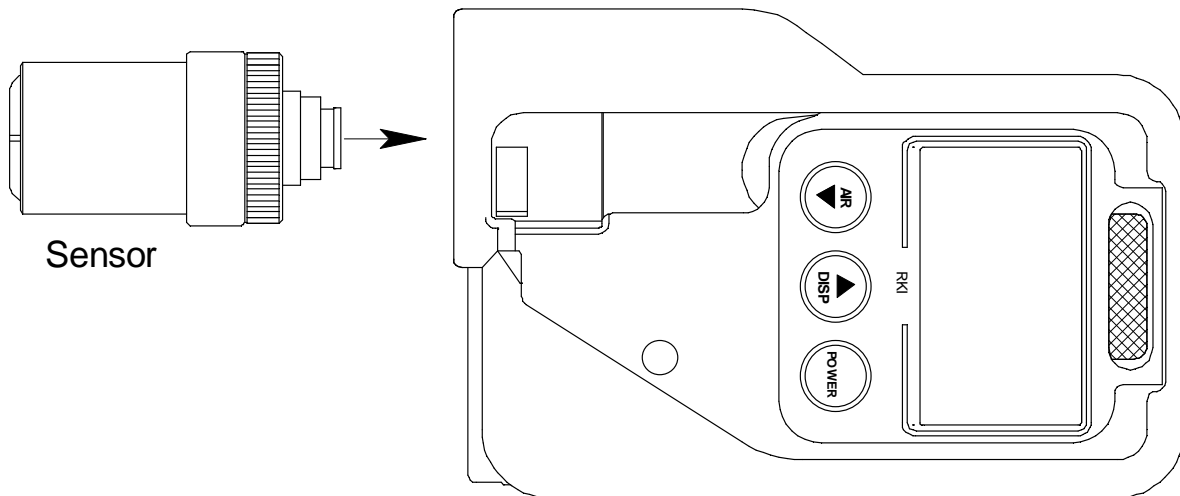

Figure 8: Inserting the New Sensor

6. With the sensor plug gently touching sensor socket, turn the sensor clockwise or counterclockwise while pushing the sensor very lightly until you feel it drop into place as the sensor plug aligns with the sensor socket and partially engages it. With the sensor plug and sensor socket partially engaged, the sensor will no longer rotate freely.

CAUTION: Do not force the sensor into the sensor socket. Forcing a sensor into the sensor socket may damage the sensor or the socket.

7. With the sensor plug and sensor socket partially engaged, push the sensor into the SC-01 so that the sensor plug fully engages the sensor socket. This will push the sensor in about 1/16" farther than the partially engaged position.
8. Align the yellow line on the sensor retainer's rubber guard with the "UNLOCK" line on the case and slide the sensor retainer over the sensor and push it into the sensor opening over the sensor.

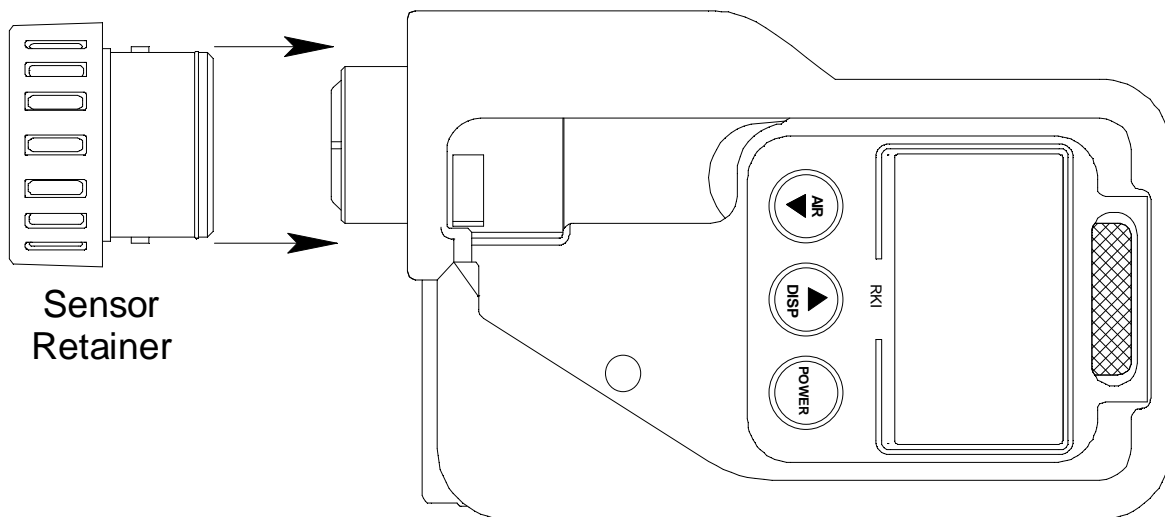
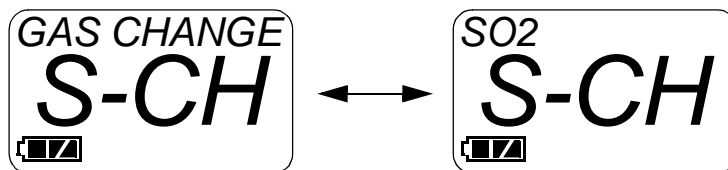

Figure 9: Installing the Sensor Retainer

9. Make sure the tab on the sensor retainer below the yellow line engages the mating notch in the case's sensor opening, then push the sensor retainer as far as it will go and turn it 1/8 turn clockwise until it locks in place.
10. Allow 5 minutes for the new sensor to stabilize.

11. Press and briefly hold the POWER button until you hear a beep to turn on the SC-01. After a few seconds, the screen shown on the left below will appear with the “S-CH” flashing indicating that the sensor has been changed. After a few seconds, the two screens will begin alternating. In the example below, the target gas is SO₂.



12. Press and release the POWER button and the startup sequence will begin as described in “Start-up Procedure” on page 13. At the end of the startup sequence, instead of entering Measuring Mode, the SC-01 will proceed automatically to the AIR CAL menu item in Setup Mode.
13. If the sensor calibration is due or if you are not sure that the sensor has been recently calibrated, calibrate the new sensor as described in “Performing a Fresh Air Adjustment” on page 26 and “Performing a Span Adjustment” on page 27.

If you do not want to perform a calibration, press and release the AIR ▼ button until you arrive at the START screen, then press and release the POWER button to enter Measuring Mode.

Changing the SC-01’s Target Gas

The SC-01 sensor stores various parameters including the target gas, detection range, and alarm points. Because of this, the sensor type can be changed on the SC-01 without any setup required to begin monitoring for a different target gas if the sensor is replaced with one of a different type as long as the new sensor is calibrated.

To change the SC-01’s target gas, replace the sensor as described above in “Replacing the Sensor” with a sensor of a different type. For example, if you have an SC-01 for SO₂ and you want to change it to detect NH₃, just replace the SO₂ sensor with a NH₃ sensor and calibrate the new sensor if necessary.

Parts List

Table 8 lists replacement parts and accessories for the SC-01.

Table 8: Parts List

Part Number	Description
06-1283RK	Calibration kit sample tube, 3 feet, teflon tube w/flexible polyurethane ends
13-0215RK	Alligator clip
13-0217RK	Belt Clip
20-0322RK	Rubber boot
21-1875RK	Battery cover
21-1876RK	Sensor retainer w/rubber guard and o-rings
47-1561RK	Extender cable, 3 meter, SC-01
47-5026RK	Cable, serial/IrDA adapter
47-5027RK	Cable, USB/IrDA adapter
49-1120RK	AA size alkaline battery (2 required for SC-01)
71-0136RK	SC-01 Operator's Manual (this document)
71-0138RK	SC-01 Data Logger Management Program
81-0062RK-01	Calibration cylinder, 50 ppm CO in nitrogen, 34 liter
81-0062RK-04	Calibration cylinder, 50 ppm CO in nitrogen, 103 liter
81-0151RK-02	Calibration cylinder, 25 ppm H ₂ S in nitrogen, 58 liter
81-0151RK-04	Calibration cylinder, 25 ppm H ₂ S in nitrogen, 34 liter
81-0170RK-02	Calibration cylinder, 5 ppm SO ₂ in nitrogen, 58 liter
81-0170RK-04	Calibration cylinder, 5 ppm SO ₂ in nitrogen, 34 liter
81-0175RK-02	Calibration cylinder, 10 ppm NH ₃ in nitrogen, 58 liter
81-0175RK-04	Calibration cylinder, 10 ppm NH ₃ in nitrogen, 34 liter
81-0185RK-02	Calibration cylinder, 0.5 ppm PH ₃ in nitrogen, 58 liter
81-0185RK-04	Calibration cylinder, 0.5 ppm PH ₃ in nitrogen, 34 liter
81-0192RK-02	Calibration cylinder, 2 ppm Cl ₂ in nitrogen, 58 liter

Table 8: Parts List

Part Number	Description
81-0192RK-04	Calibration cylinder, 2 ppm Cl ₂ in nitrogen, 34 liter
81-1051RK	Regulator, fixed flow, w/gauge & knob, 0.5 LPM, for 34 liter aluminum/58 liter/103 liter cylinder,
81-1051RK-25	Regulator, fixed flow, w/gauge & knob, 0.25 LPM, for 34 liter aluminum/58 liter/103 liter cylinder (Used to calibrate NH₃ instrument only)
81-1139RK	Calibration cup, general (not for Cl ₂ or NH ₃)
81-1139RK-CL2	Calibration cup for Cl ₂ SC-01
81-1139RK-NH3	Calibration cup for NH ₃ SC-01
81-SC01CL2	Calibration kit for Cl ₂ SC-01, 58 liter
81-SC01CL2-LV	Calibration kit for Cl ₂ SC-01, 34 liter
81-SC01CO	Calibration kit for CO SC-01, 103 liter
81-SC01CO-LV	Calibration kit for CO SC-01, 34liter
81-SC01H2S	Calibration kit for H ₂ S SC-01, 58 liter
81-SC01H2S-LV	Calibration kit for H ₂ S SC-01, 34 liter
81-SC01NH3	Calibration kit for NH ₃ SC-01, 58 liter
81-SC01NH3-LV	Calibration kit for NH ₃ SC-01, 34 liter
81-SC01PH3	Calibration kit for PH ₃ SC-01, 58 liter
81-SC01PH3-LV	Calibration kit for PH ₃ SC-01, 34 liter
81-SC01SO2	Calibration kit for SO ₂ SC-01, 58 liter
81-SC01SO2-LV	Calibration kit for SO ₂ SC-01, 34liter
82-5011RK-SER	Downloading kit w/software & serial/IrDA cable
82-5011RK-USB	Downloading kit w/software & USB/IrDA cable
83-0010RK	Downloading software, SC-01
ESM-011-CO	Sensor, CO (carbon monoxide), 0 - 75.0 ppm
ESM-017-H2S	Sensor, H2S (hydrogen sulfide), 0 - 30.0 ppm

Table 8: Parts List

Part Number	Description
ESM-01DH-D-SO2	Sensor, SO ₂ (sulphur dioxide), 0 - 6.00 ppm, diffusion only type
ESM-01DH-PH3	Sensor, PH ₃ (phosphine), 0 - 1.00 ppm
ESM-01R-D-NH3	Sensor, NH ₃ (ammonia), 0 - 75.0 ppm, diffusion only type
ESM-K01-D-CL2	Sensor, Cl ₂ (chlorine), 0 - 3.00 ppm, diffusion only type